



# Tidewater Lumber & Moulding, Inc.

## *Classics*

2013

CATALOG

*Edition*

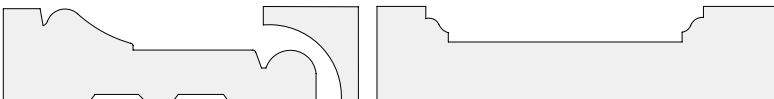
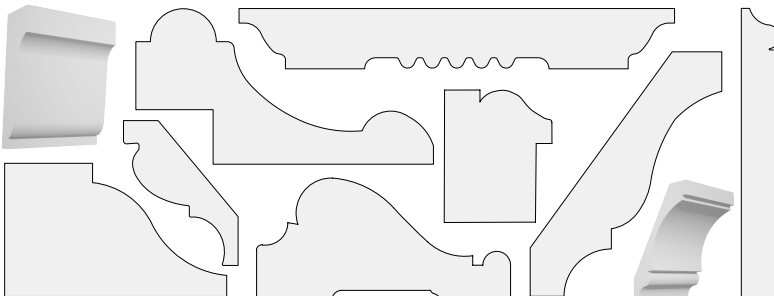

Greenville, SC | (864) 987-9663 | FAX (864) 987-0685

[www.tidewaterlumberinc.com](http://www.tidewaterlumberinc.com)



Tidewater Lumber and Moulding has been in business for over 25 years. Ed Voorhees started Tidewater by providing value added services to lumber such as planing, ripping, and moulding. Today we stock over 25 species of lumber.

We manufacture many different products such as architectural mouldings, flooring, paneling, decking, and flooring accessories. We also distribute lumber and plywood to cabinet makers and custom furniture builders.

We deliver within a 150 mile radius with our own fleet of trucks, and anything out of our delivery area is shipped on a flatbed or LTL. We also have great discounts available on rush orders.

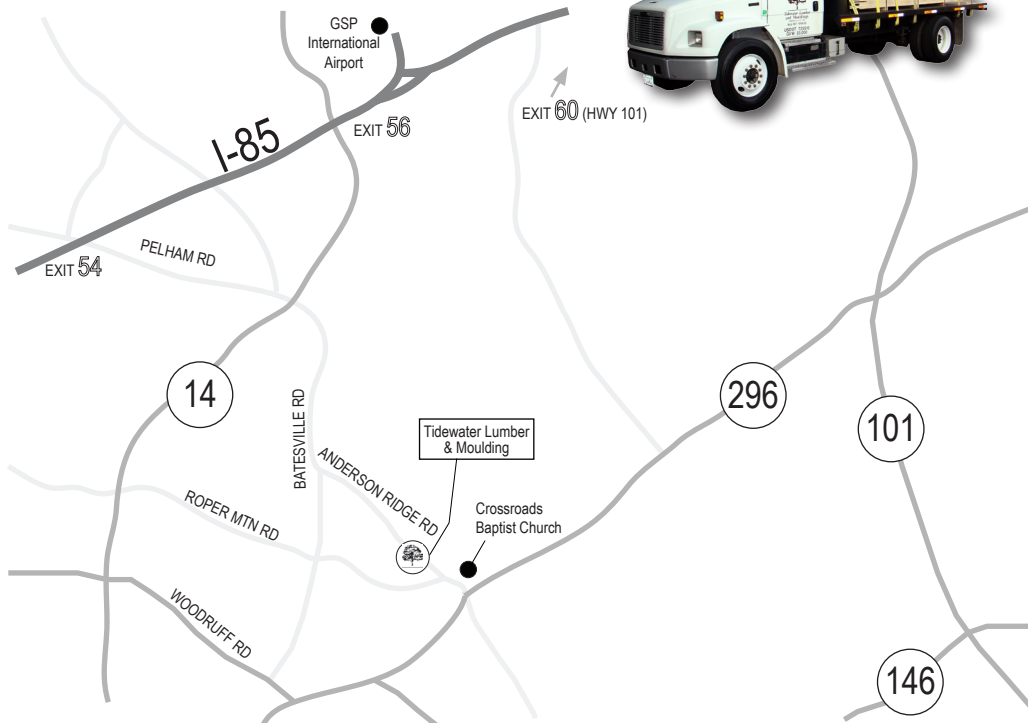

**PLANT:** 596 Anderson Ridge Rd  
Greer, SC 29651

**MAILING:** 109 Ponders Ray Lane  
Greenville, SC 29615

**PHONE:** (864) 978-9663

**FAX:** (864) 978-0685

**[www.tidewaterlumberinc.com](http://www.tidewaterlumberinc.com)**



Classics

# TABLE OF CONTENTS



## CASINGS

TW 1	1 3/4" x 6"	1
TW 2	1 1/4" x 4 1/4"	2
TW 3	1 1/4" x 4 1/2"	2
TW 4	1 1/4" x 3 3/4"	2
TW 5	1 1/16" x 3 1/2"	3
TW 8	1" x 3"	3
TW 9	1 1/4" x 3 1/2"	3
TW 17	3/4" x 3 1/4"	4
TW 23	3/4" x any width	4
TW 25	3/4" x 3 1/2"	4
TW 34	3/4" x 5 1/4"	5
TW 36	3/4" x 3 1/2"	5
TW 40	13/16" x 3 1/2"	5
TW 41	5/8" x 2 1/4"	6
TW 50	1" x 3 1/2"	6
TW 62	1 1/4" x 4 1/4"	6
TW 65	1 1/4" x 4 1/2"	6
TW 67	1 3/4" x 3 1/4"	7
TW 68	1 3/4" x 5 3/4"	7
TW 70	3/4" x 7 1/4"	7
TW 75	1 1/4" x 4 1/4"	8
TW 76	1 3/4" x 6"	8
TW 1014	1 1/16" x 3 9/16"	8

## BACK BANDS

TW 79	1 3/8" x 1 3/4"	9
TW 80	1 1/8" x 1 3/16"	9
TW 83	1 1/16" x 2"	9
TW 84	1 1/2" x 1 1/2"	9
TW 92	1 1/16" x 1 5/16"	9

## CROWNS

TW 101	9/16" x 2 3/4"	10
TW 102	11/16" x 3 1/2"	10
TW 103	11/16" x 4 1/2"	11
TW 104	11/16" x 5 1/2"	11
TW 108	7/8" x 4 1/8"	11
TW 109	5/8" x 1 5/8"	11
TW 110	1 5/16" x 3 1/2"	12
TW 111	5/8" x 2 3/4"	12
TW 114	3/4" x 4 3/8"	12
TW 118	3/4" x 5 1/2"	12
TW 122	1" x 3 1/4"	13
TW 123	1 1/8" x 5 7/8"	13
TW 124	1" x 4 1/4"	13
TW 128	1 5/8" x 6 7/8"	14
TW 129	7/8" x 5 3/4"	14
TW 130	1 1/8" x 5 1/2"	14

## CROWNS cont.

TW 132	1" x 7 1/2"	15
TW 135	1 7/8" x 10 1/2"	15
TW 138	1 1/16" x 4"	16
TW 143	1 5/8" x 10 3/4"	16
TW 147	13/16" x 4 3/4"	16
TW 150	3/4" x 2 7/8"	17
TW 900	3/4" x 5"	17
TW 901	5/8" x 1 7/8"	17
TW 904	7/8" x 2 7/8"	17
TW 906	1 7/16" x 7 1/4"	18
TW 909	1 1/4" x 6 7/8"	18
TW 919	3/4" x 3 1/8"	19
TW 920	3/4" x 4 1/4"	19
TW 931	3/4" x 2 1/4"	19
TW 936	7/8" x 2 1/2"	19
TW 939	1 3/4" x 8 3/4"	20
TW 944	1 1/8" x 7 1/4"	20
TW 952	1" x 6 3/4"	21
TW 955	1 1/4" x 7 1/4"	21

## PICTURE MOULD

TW 155	3/4" x 1 3/4"	22
--------	---------------	----

## APRONS

TW 176	3/4" x 2 1/2"	22
TW 178	13/16" x 3 1/2"	22
TW 179	13/16" x 3 1/2"	22

## SPEED BASE

TW 181	3/4" x 5 1/2"	23
TW 183-S	7/8" x any height	23
TW 186	3/4" x 5 1/2"	23
TW 190	3/4" x 5 1/4"	23
TW 199	3/4" x 3 1/4" to 8 1/4"	24
TW 1106	3/4" x 5 1/2"	24
	3/4" x 7 1/4"	
TW 1109	3/4" x any height	24

## BASE CAPS

TW 202	1" x 1 5/8"	25
TW 204	5/8" x 3/4"	25
TW 205	3/4" x 1 3/8"	25
TW 210	3/4" x 1 3/8"	25

## CHAIR RAILS

TW 250	3/4" x 2 1/2"	26
TW 253	3/4" x 3 1/4"	26
TW 254	3/4" x 3 1/8"	26
TW 256	1 1/4" x 3 1/4"	26
TW 258	1 1/4" x 3"	27
TW 263	7/8" x 2 1/4"	27
TW 264	3/4" x 5 1/4"	27
TW 265	1 1/4" x 2 3/4"	28
TW 276	9/16" x 4 1/4"	28
TW 277	1" x 2 11/16"	28
TW 280	1" x 4"	29
TW 282	3/4" x 5"	29
TW 286	3/4" x 3"	29

## APPLIED MOULDS

TW 334	7/16" x 13/16"	30
TW 338	3/4" x 1 1/4"	30
TW 340	7/8" x 2 1/4"	30
TW 341	3/4" x 1 1/8"	30
TW 342	3/4" x 1 1/4"	30
TW 351	1 1/16" x 2 1/8"	30
TW 360	3/4" x 1 5/8"	30
TW 366	5/8" x 1 5/8"	30
TW 371	1 3/4" x 2 1/2"	30
TW 372	1 1/2" x 2 7/8"	31
TW 375	1 1/4" x 2 1/8"	31
TW 384	1 7/16" x 2"	31
TW 385	7/8" x 1"	31
TW 388	1 3/8" x 2"	31
TW 392	1 1/4" x 2 13/16"	31
TW 395	5/8" x 13/16"	32
TW 804	1" x 1 1/2"	32
TW 818	9/16" x 1 5/16"	32
TW 821	1 1/2" x 3/4"	32
TW 826	1 3/4" x 2"	32
TW 828	3/4" x 1 3/4"	32
TW 836	1 7/8" x 3 1/2"	32

## WINDOW PARTS

TW 402	1 1/16" x 3 1/2"	33
	1 1/16" x 5 1/2"	
TW 404	3/4" x 3 1/4" / any width	33

## HAND RAILS

TW 428	1 5/8" x 6 7/8"	34
TW 432	1 1/2" x 4 1/8"	34



Classics

# TABLE OF CONTENTS



## MANTLE MOULD

TW 453	13/16" x 4 9/16"	35
--------	------------------	----

## FLOORING

Stock	-	36
TW 500	1/2" x 3/4"	36
TW 502	3/4" x 3/4"	36
TW 504	5/16" x 1 1/2"	36
TW 505	5/8" x 1 7/8"	37
TW 506	11/16" x 2"	37
TW 507	13/16" x 2 1/4"	37
TW 508	1" x 5 1/4"	37
TW 513	9/16" x 3/4"	37

## PANELING

TW 601	3/4" x 5 1/2" & 7 1/4"	38
TW 602	3/4" x 3 3/8"	38
TW 603	3/4" x 5 1/4"	38
TW 605	3/4" x 5 1/2"	39
TW 609	3/4" x 4 1/2"	39
TW 610	1 1/2" x 7 1/4"	39
TW 616	3/4" x 7 1/4"	39

## SIDING

TW 625	3/4" x any width	40
TW 628-B	3/4" x 7 1/8"	40
TW 629	3/4" x 5 1/2"	41
	3/4" x 7 1/4"	
TW 630	13/16" x any width	41

## PLINTHBLOCKS

TW 700	2" x 5"	42
TW 703	1 1/4" x 3 3/4"	42
TW 704	1 3/8" x 4 1/4"	42
TW 706-M	2 1/16" x 5 3/4"	43
TW 707	1 1/2" x 4 1/2"	43

## QUARTER ROUNDS

-	1/2"	44
-	5/8"	44
-	3/4"	44
-	7/8"	44
-	1"	44
-	1 1/4"	44
-	1 1/2"	44

## COVES

-	1/2" x 1/2"	44
-	5/8" x 5/8"	44
-	3/4" x 3/4"	44
-	3/4" x 1"	44
-	1 1/16" x 1"	44
-	1 1/2" x 1 1/2"	44

## HALF ROUNDS

-	1/2"	45
-	3/8" x 3/4"	45
-	3/4"	45
-	1" x 2"	45
-	1 1/4" x 2 1/2"	45
-	1 1/2" x 3"	45
-	2" x 4"	45

## DECKING

Accessories	46
3/4" x 3 1/2"	47
3/4" x 5 1/2"	47
1" x 5 1/2"	47
1" x 5 1/2"	47

## TIMBERS

48

## CABINET LUMBER STOCK

- Alder 4/4 Superior
- Alder 4/4 Cabinet Grade
- Alder 5/4
- Alder 8/4
- Ash 4/4
- Ash 5/4
- Cherry 4/4
- Cherry 4/4 x 8" & wider
- Cherry 5/4
- Cherry 8/4
- Wormy Chestnut 4/4
- Eastern Red Cedar 4/4
- E W Pine-Knotty 4/4
- E W Pine 1x12
- Hickory 4/4
- Hickory 5/4
- Mahogany - African 4/4
- Mahogany - African 5/4
- Mahogany - African 6/4
- Mahogany - African 8/4
- Poplar 4/4
- Poplar 4/4 x 12" & wider
- Poplar 5/4
- Poplar 6/4
- Poplar 8/4
- Quarter Sawn Red Oak
- Quarter Sawn White Oak
- Red Oak 4/4
- Red Oak 5/4
- Red Oak 6/4
- Red Oak 8/4
- Red Oak 4/4 #1 Common
- Red Oak 4/4 x 10" & wider
- Rift Sawn Red Oak
- Rift Sawn White Oak
- Wormy Sassafras 4/4 FAS
- Soft Maple 4/4 (Paint Grade)
- Soft Maple 4/4 (Stain Grade)
- Soft Maple 4/4 Curly
- Soft Maple 5/4
- Soft Maple 8/4
- Walnut 4/4
- Walnut 8/4
- White Oak #1 Common
- White Oak 4/4
- White Oak 5/4
- White Oak 8/4
- Wormy Maple 4/4
- Wormy Oak 4/4

\*all material subject to prior sale







# Tidewater Lumber & Moulding, Inc.

Greenville, South Carolina  
(864) 987-9663 | tidewaterlumberinc.com



## CASINGS

Tidewater mills nearly 100 custom casings. Because we have an in-house knife grinding and cutting department, we can also cut casings not in the catalog, giving you a truly custom casing unique to your home or business. Over 25 species of wood are in stock to use for moulding.

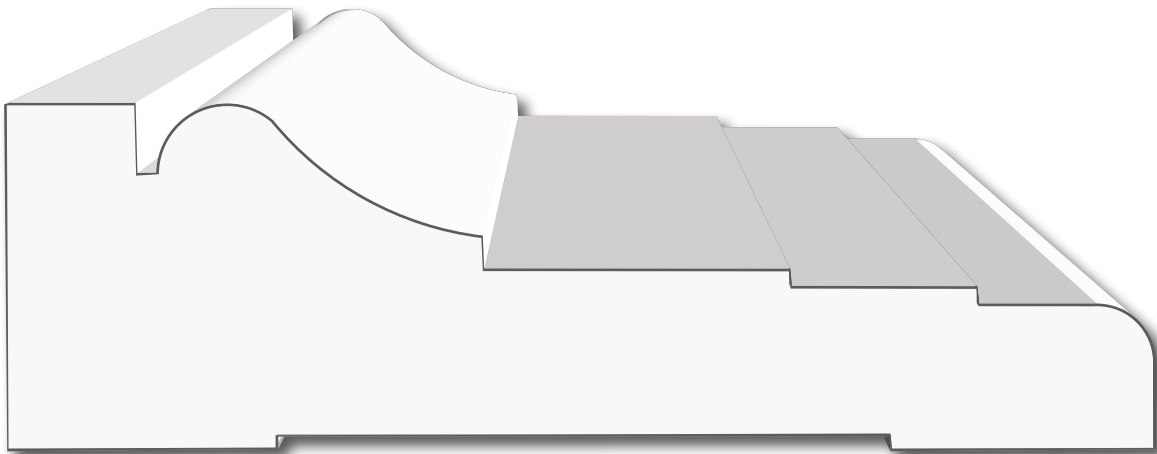

**TW 1**  
1 3/4" x 6"



Tidewater Lumber  
& Moulding, Inc.

Greenville, South Carolina  
(864) 987-9663 | tidewaterlumberinc.com



CASINGS

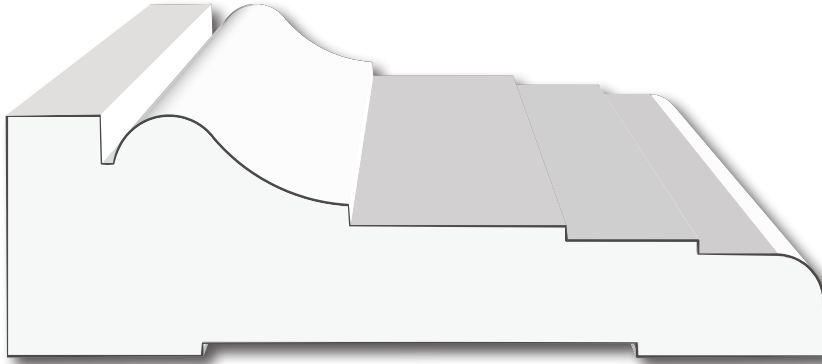

**TW 2**

1 1/4" x 4 1/4"

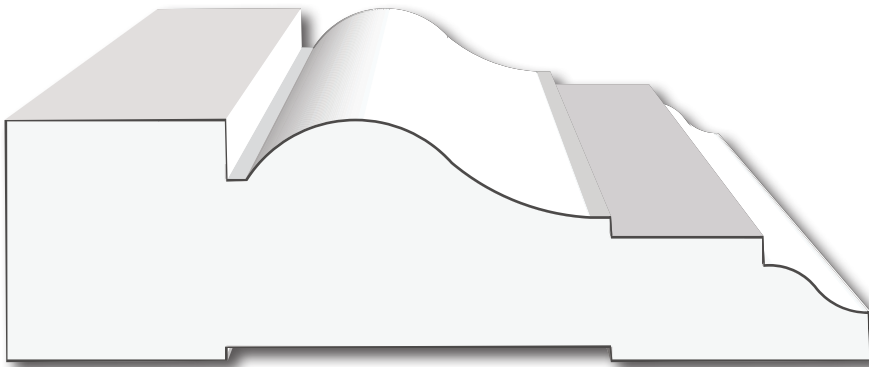

**TW 3**

1 1/4" x 4 1/2"

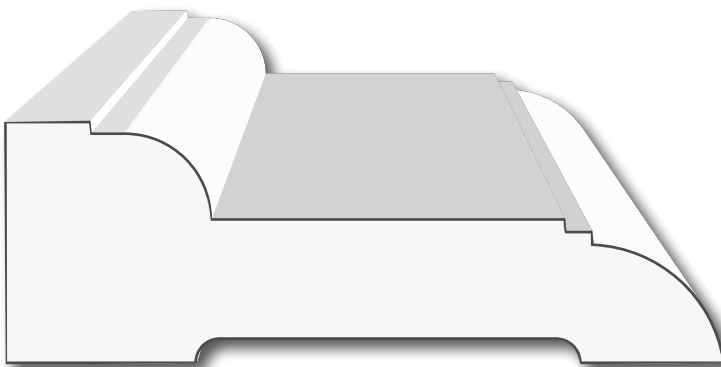

**TW 4**

1 1/4" x 3 3/4"



Tidewater Lumber  
& Moulding, Inc.

Greenville, South Carolina  
(864) 987-9663 | tidewaterlumberinc.com



CASINGS

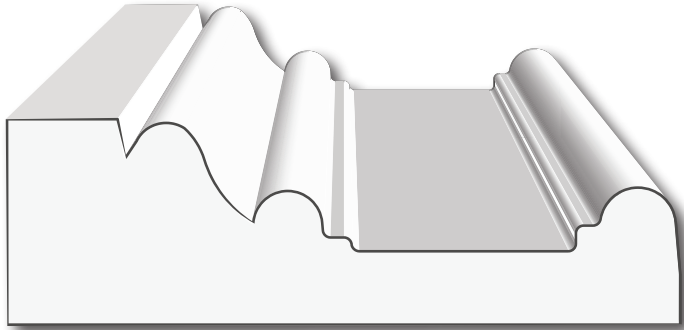

**TW 5** (RB-3)  
1 1/16" x 3 1/2"

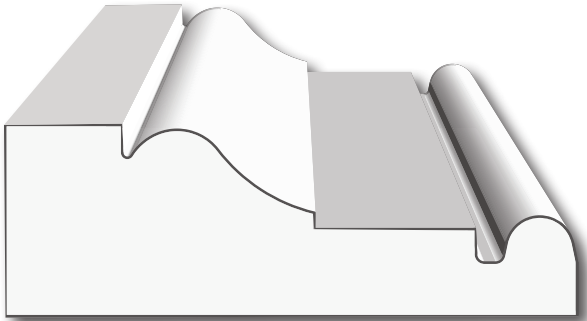

**TW 8**  
1" x 3"

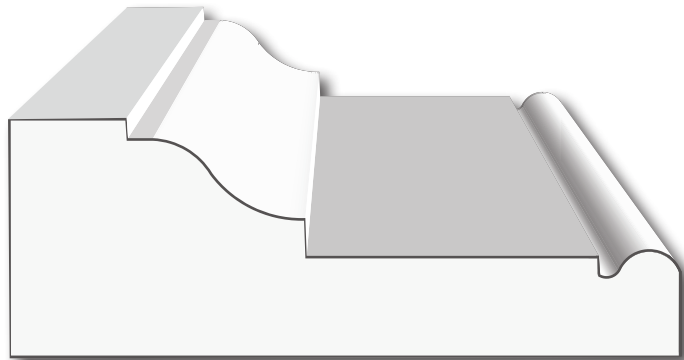

**TW 9**  
1 1/4" x 3 1/2"



Tidewater Lumber  
& Moulding, Inc.

Greenville, South Carolina  
(864) 987-9663 | tidewaterlumberinc.com



CASINGS

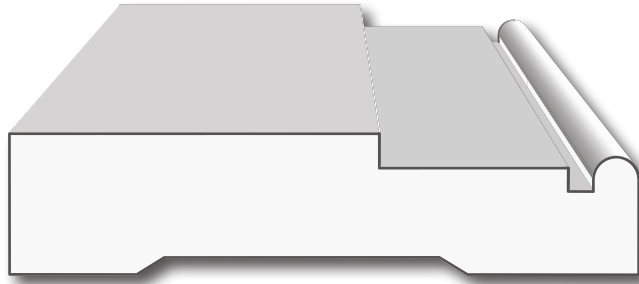

TW 17

3/4" x 3 1/4"



TW 23

3/4" x any width

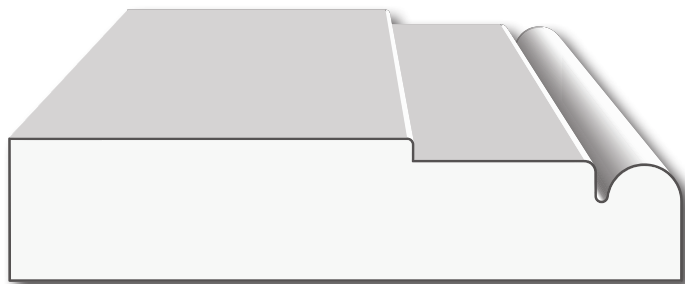

TW 25

3/4" x 3 1/2"



Tidewater Lumber  
& Moulding, Inc.

Greenville, South Carolina  
(864) 987-9663 | tidewaterlumberinc.com



CASINGS

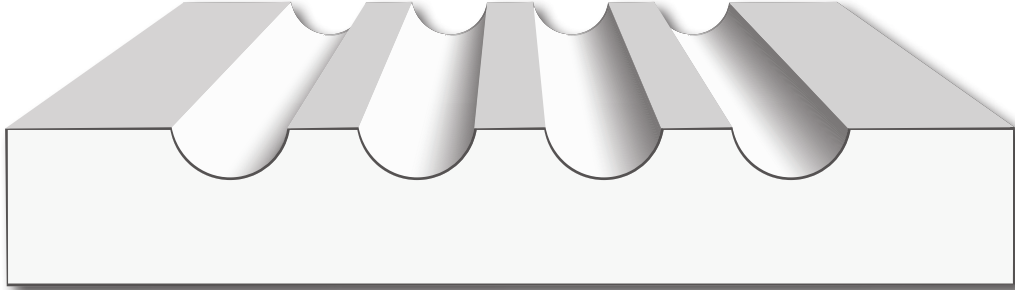

**TW 34**

3/4" x 5 1/4"

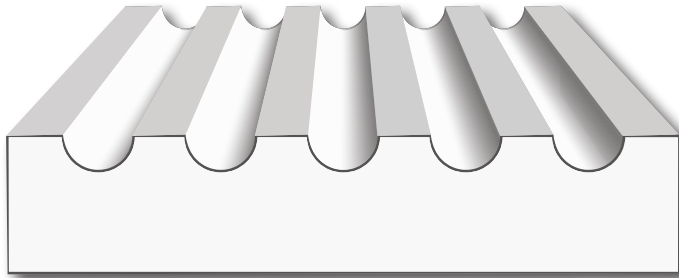

**TW 36**

3/4" x 3 1/2"

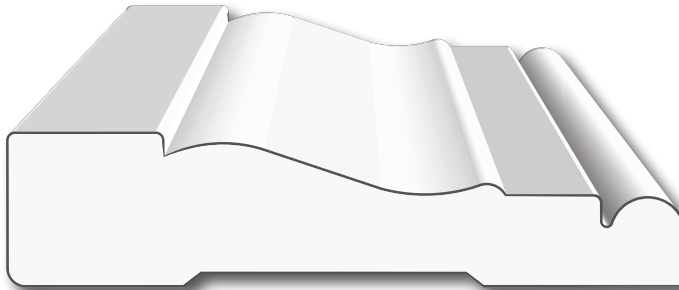

**TW 40**

13/16" x 3 1/2"





Tidewater Lumber  
& Moulding, Inc.

Greenville, South Carolina  
(864) 987-9663 | tidewaterlumberinc.com



CASINGS

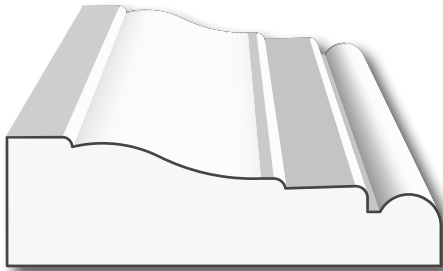

TW 41

5/8" x 2 1/4"

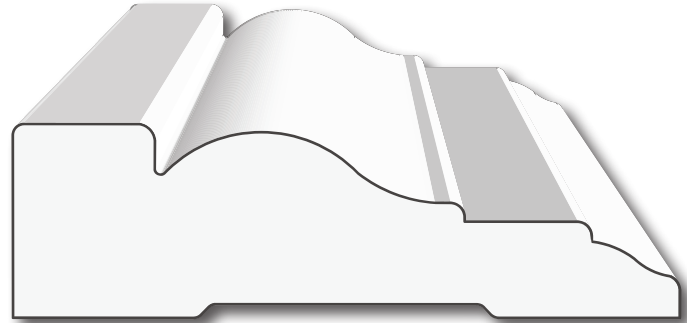

TW 50

1" x 3 1/2"

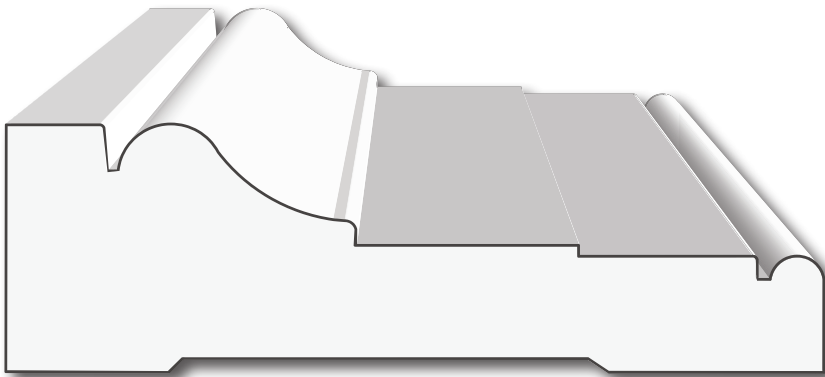

TW 62

1 1/4" x 4 1/4"

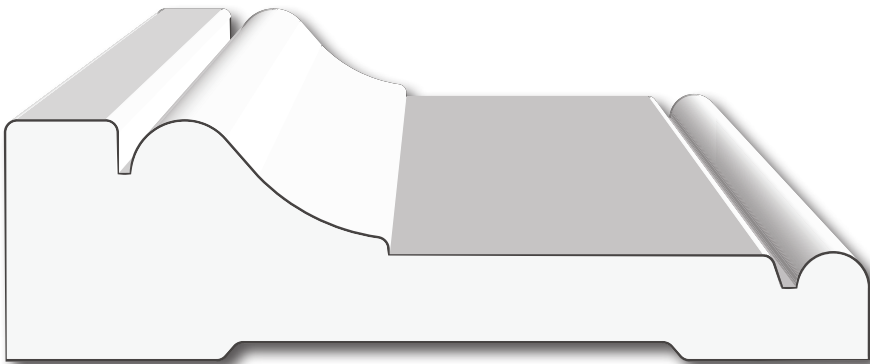

TW 65

1 1/4" x 4 1/2"



Tidewater Lumber  
& Moulding, Inc.

Greenville, South Carolina  
(864) 987-9663 | tidewaterlumberinc.com



CASINGS

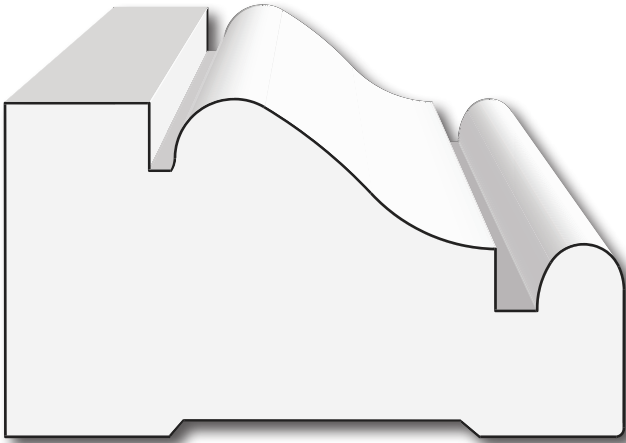

TW 67

1 3/4" x 3 1/4"

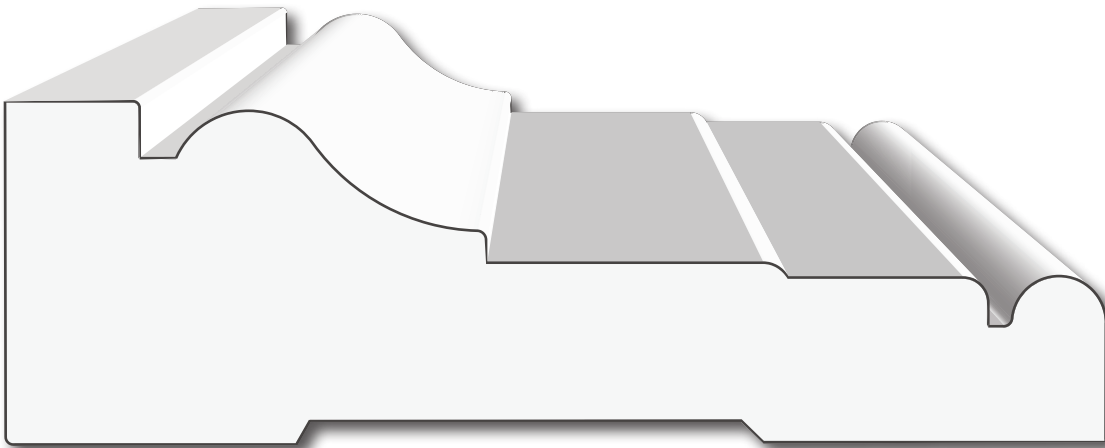

TW 68

1 3/4" x 5 3/4"

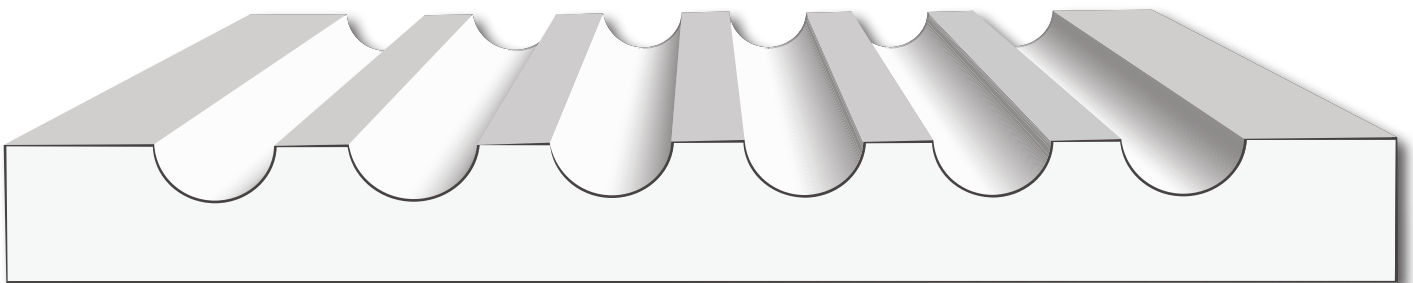

TW 70

3/4" x 7 1/4"



Tidewater Lumber  
& Moulding, Inc.

Greenville, South Carolina  
(864) 987-9663 | tidewaterlumberinc.com



CASINGS

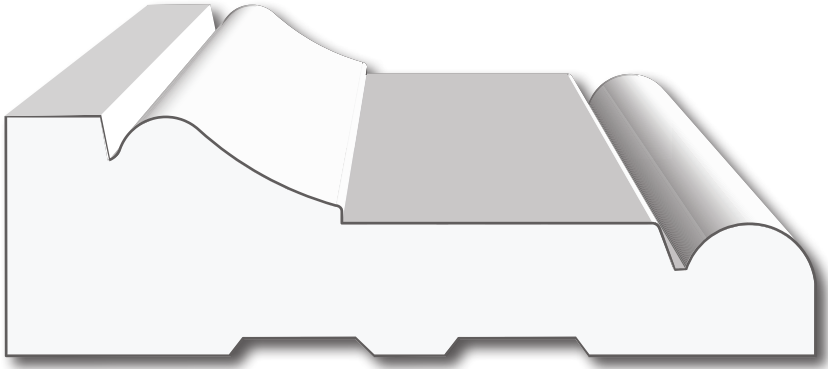

**TW 75**

1 1/4" x 4 1/4"

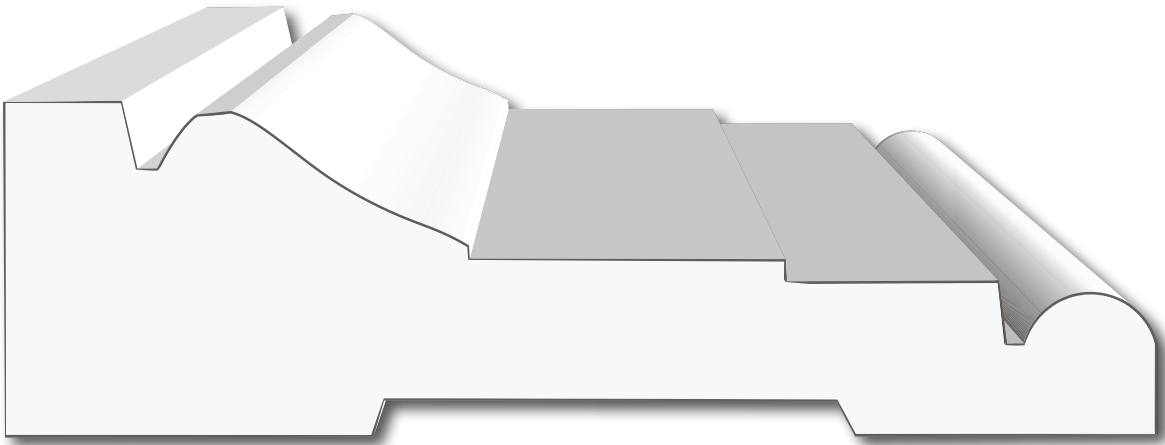

**TW 76**

1 3/4" x 6"

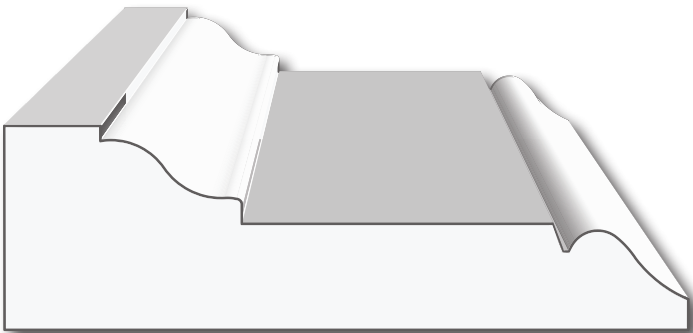

**TW 1014**

1 1/16" x 3 9/16"



Tidewater Lumber  
& Moulding, Inc.

Greenville, South Carolina  
(864) 987-9663 | tidewaterlumberinc.com



## BACK BANDS

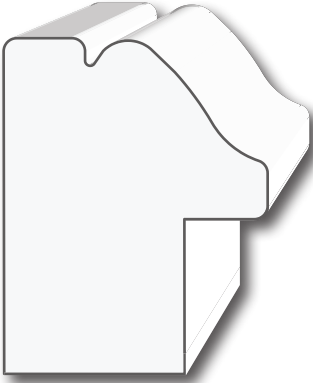

**TW 79**

1 3/8" x 1 3/4"

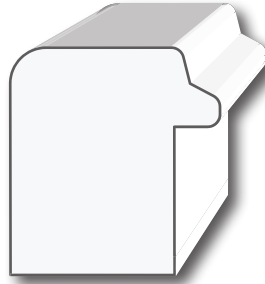

**TW 80**

1 1/8" x 1 3/16"

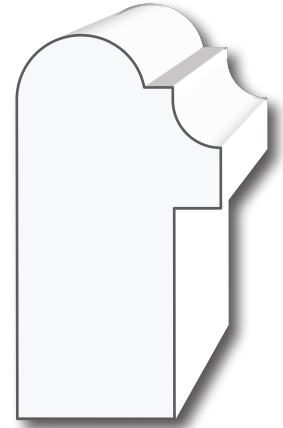

**TW 83**

1 1/16" x 2"

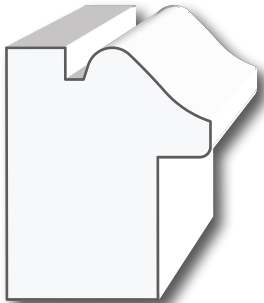

**TW 92**

1 1/16" x 1 5/16"

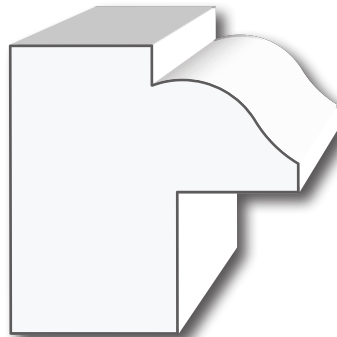

**TW 84**

1 1/2" x 1 1/2"



# CROWNS



Heart pine coffer ceiling

Tidewater mills over 100 custom crowns. Because we have an in-house knife grinding and cutting department, we can also cut crowns not in the catalog, giving you a truly custom crown unique to your home or business. Over 25 species of wood are in stock to use for moulding.

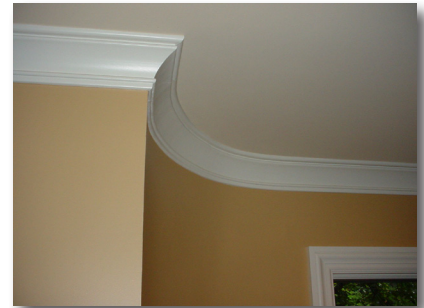

Radial crown

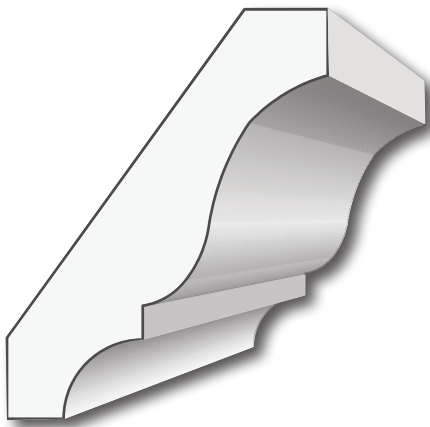

**TW 101**  
9/16" x 2 3/4"

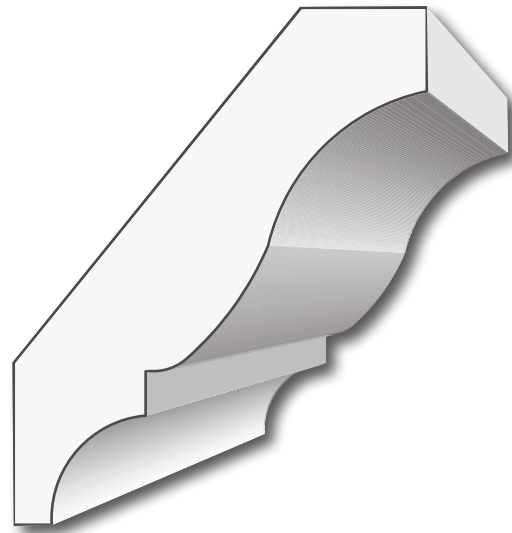

**TW 102**  
11/16" x 3 1/2"





Tidewater Lumber  
& Moulding, Inc.

Greenville, South Carolina  
(864) 987-9663 | tidewaterlumberinc.com



# CROWNS

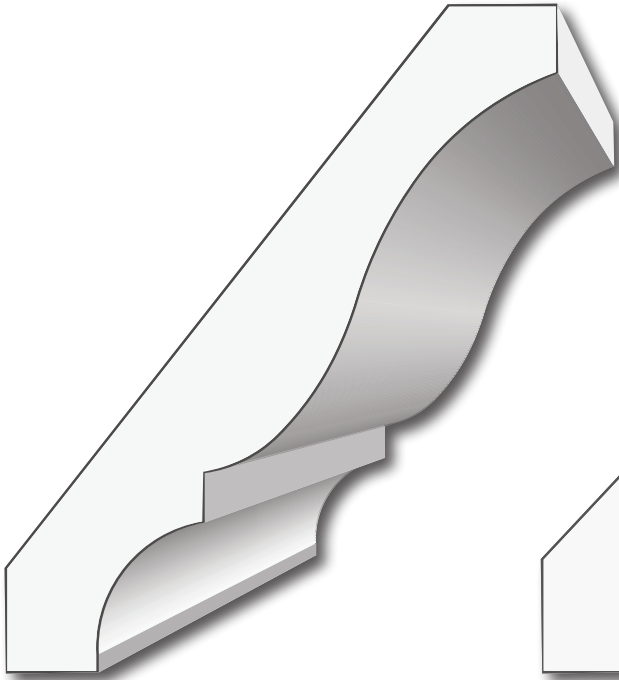

**TW 103**

11/16" x 4 1/2"

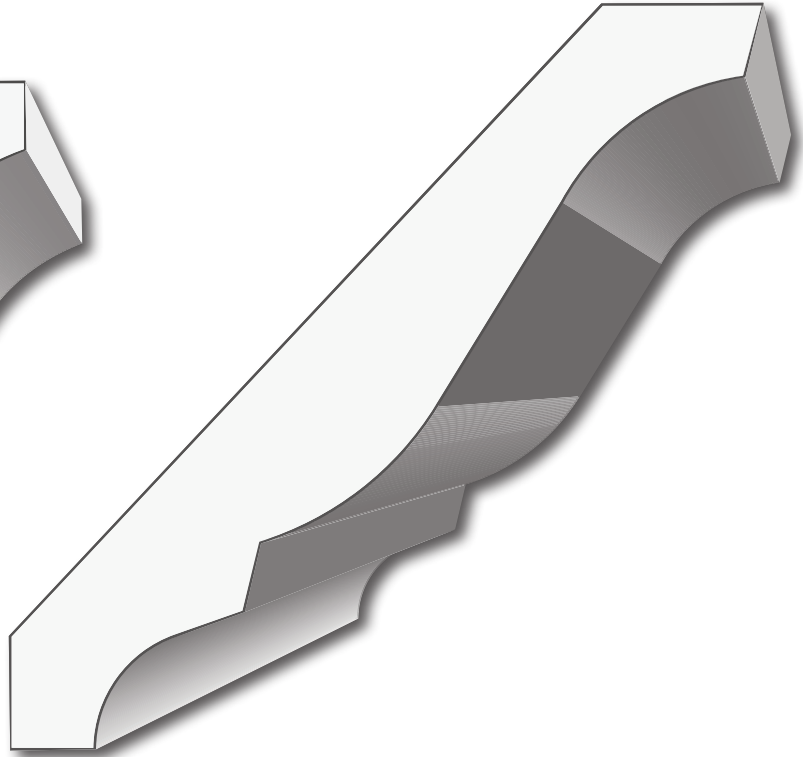

**TW 104**

11/16" x 5 1/2"

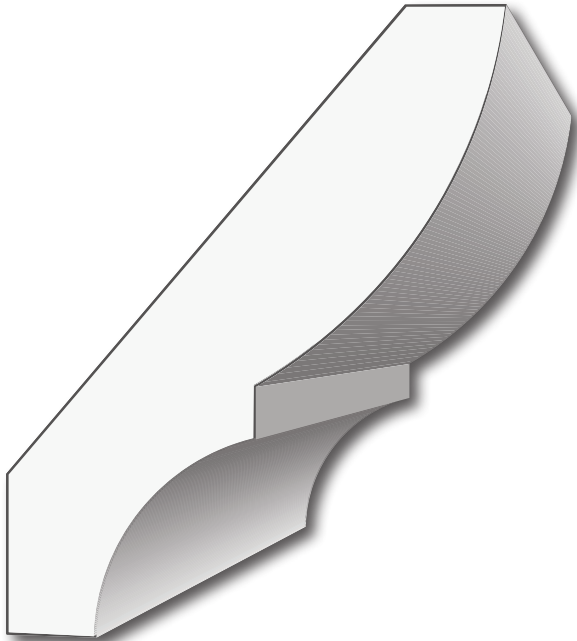

**TW 108**

7/8" x 4 1/8"

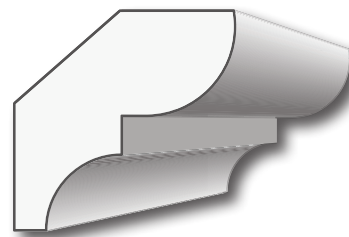

**TW 109**

5/8" x 1 5/8"



Tidewater Lumber  
& Moulding, Inc.

Greenville, South Carolina  
(864) 987-9663 | tidewaterlumberinc.com



CROWNS

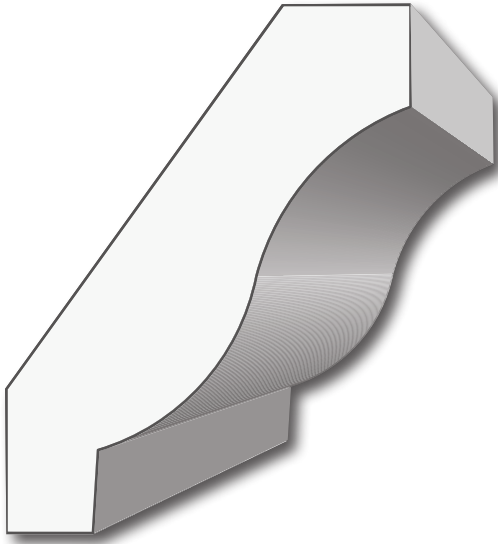

**TW 110**  
1 5/16" x 3 1/2"

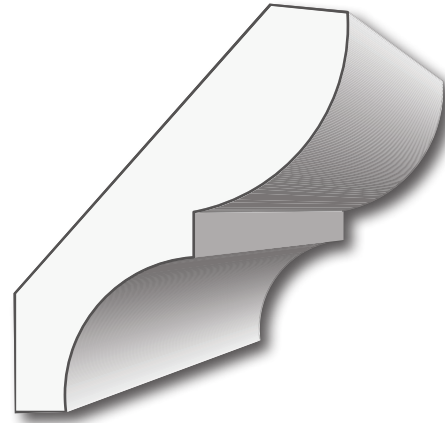

**TW 111**  
5/8" x 2 3/4"

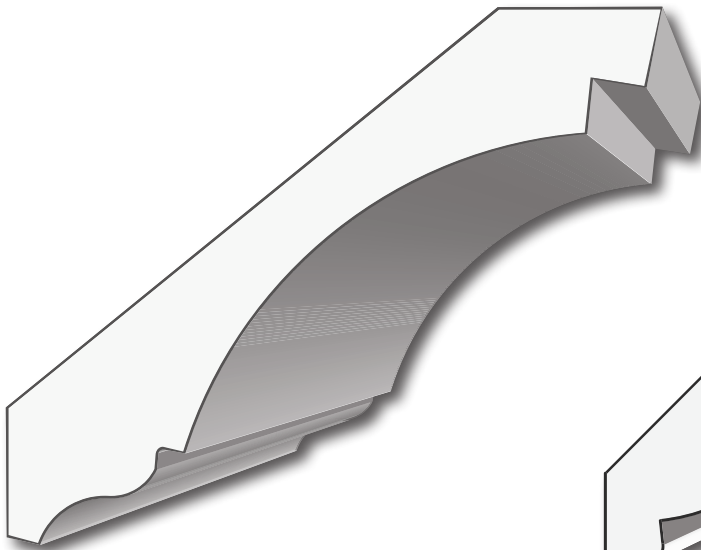

**TW 114**  
3/4" x 4 3/8"

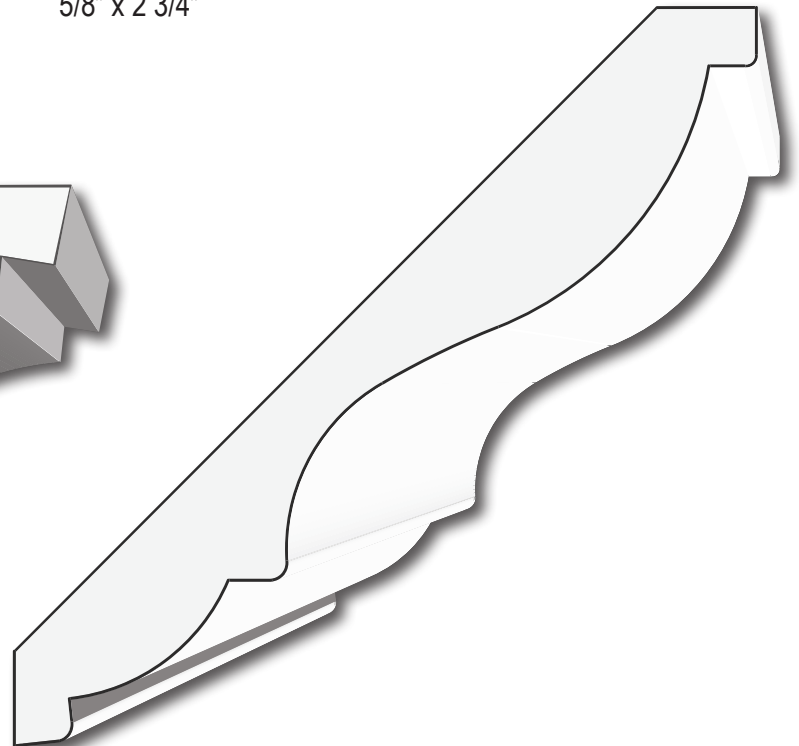

**TW 118**  
3/4" x 5 1/2"



Tidewater Lumber  
& Moulding, Inc.

Greenville, South Carolina  
(864) 987-9663 | tidewaterlumberinc.com



CROWNS

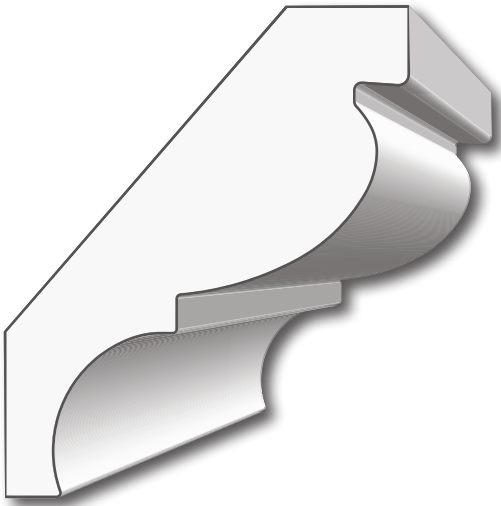

**TW 122**  
1" x 3 1/4"

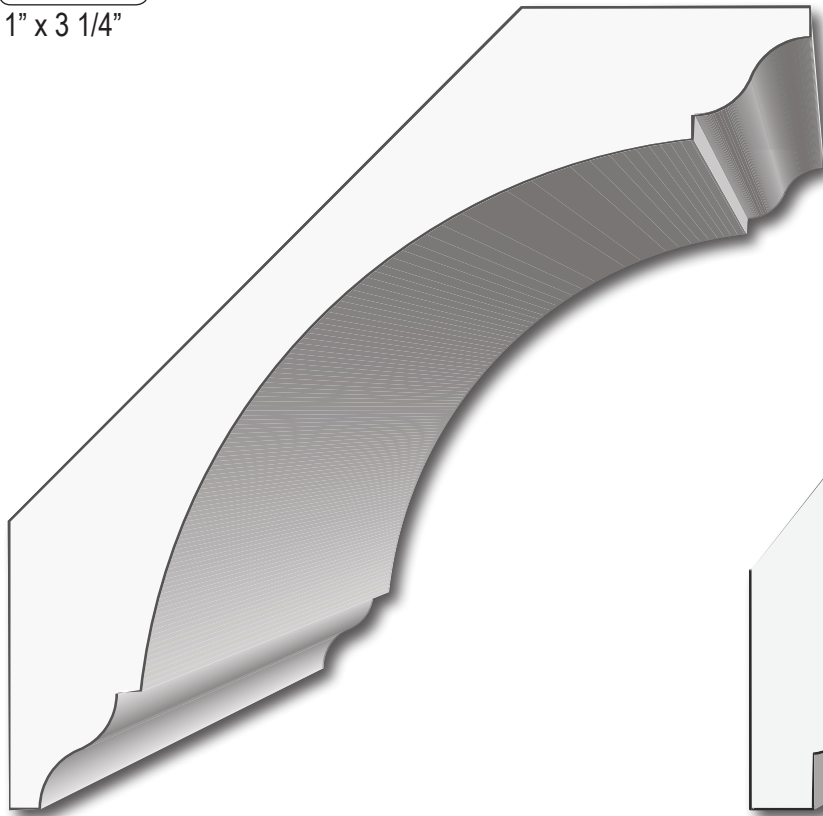

**TW 123**  
1 1/8" x 5 7/8"

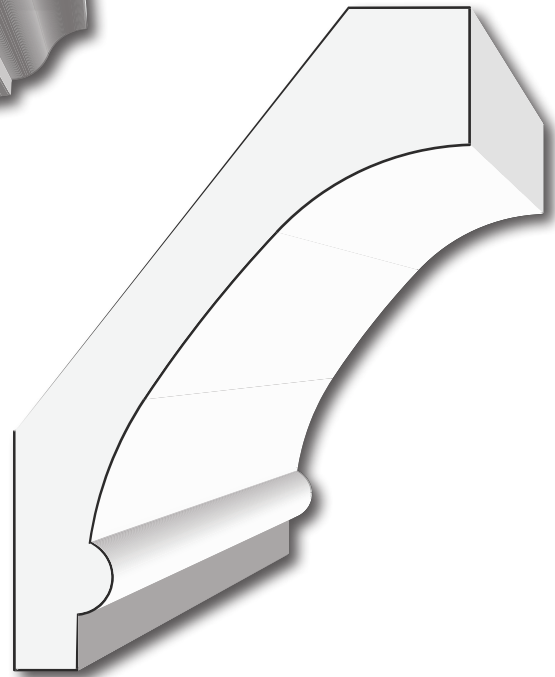

**TW 124**  
1" x 4 1/4"



Tidewater Lumber  
& Moulding, Inc.

Greenville, South Carolina  
(864) 987-9663 | tidewaterlumberinc.com



CROWNS

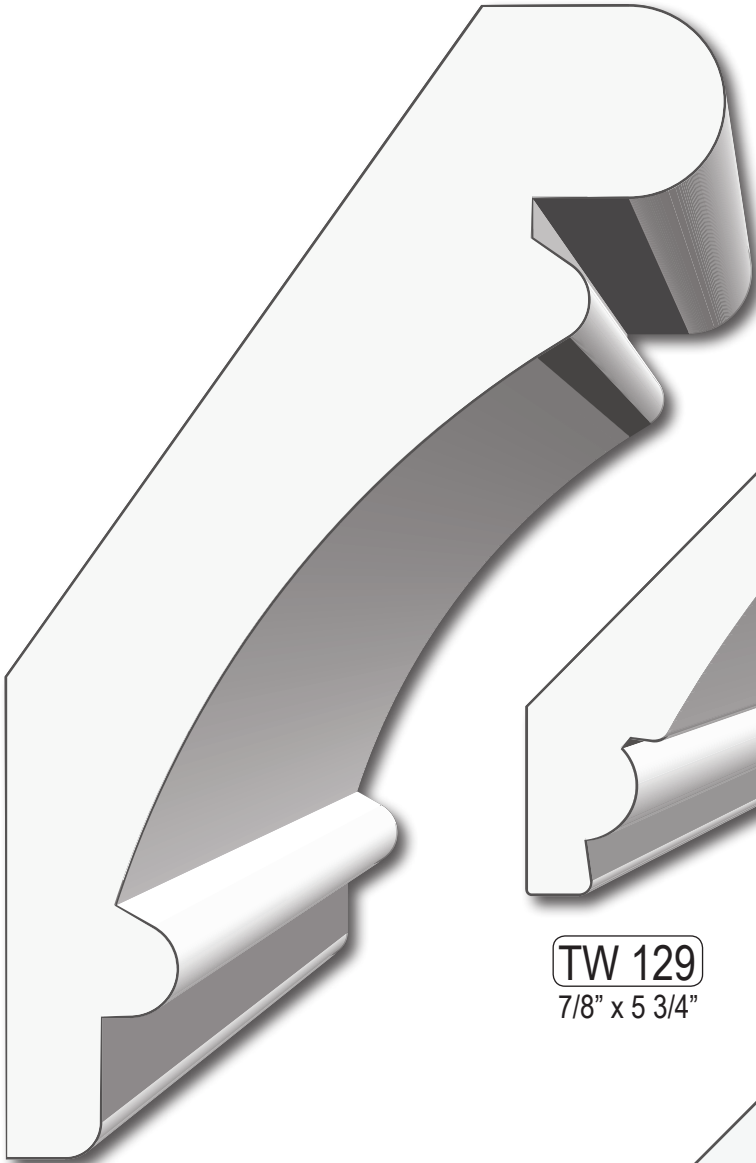

**TW 128**  
1 5/8" x 6 7/8"

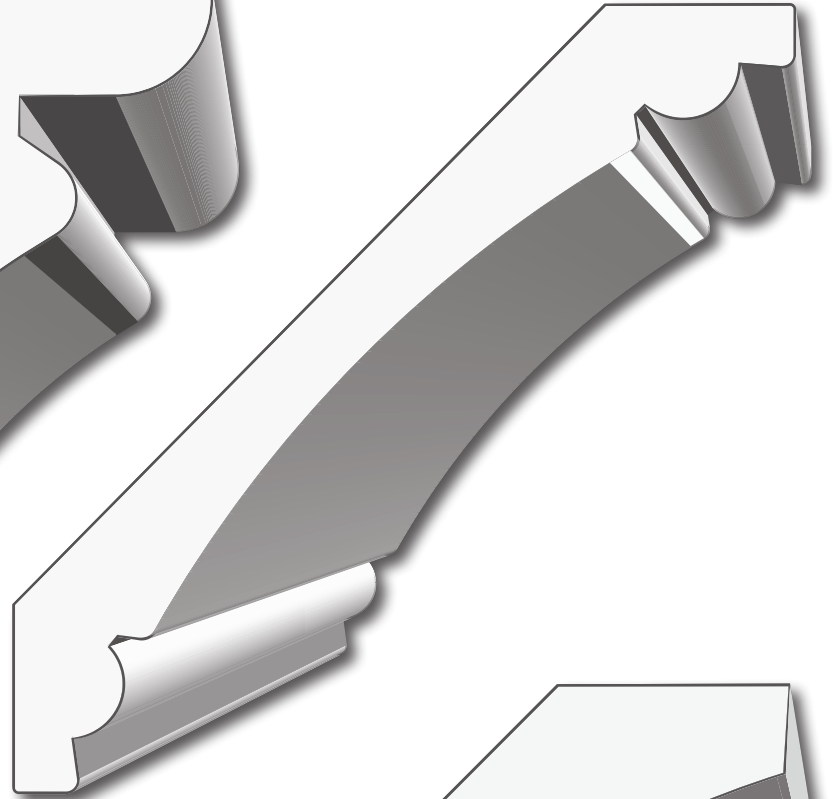

**TW 129**  
7/8" x 5 3/4"

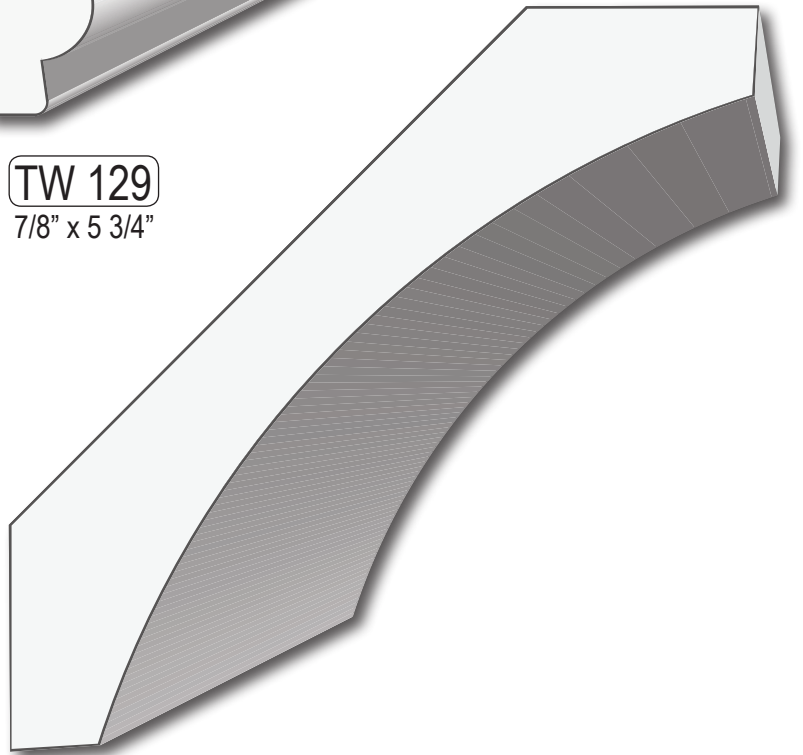

**TW 130**  
1 1/8" x 5 1/2"



Tidewater Lumber  
& Moulding, Inc.

Greenville, South Carolina  
(864) 987-9663 | tidewaterlumberinc.com



CROWNS

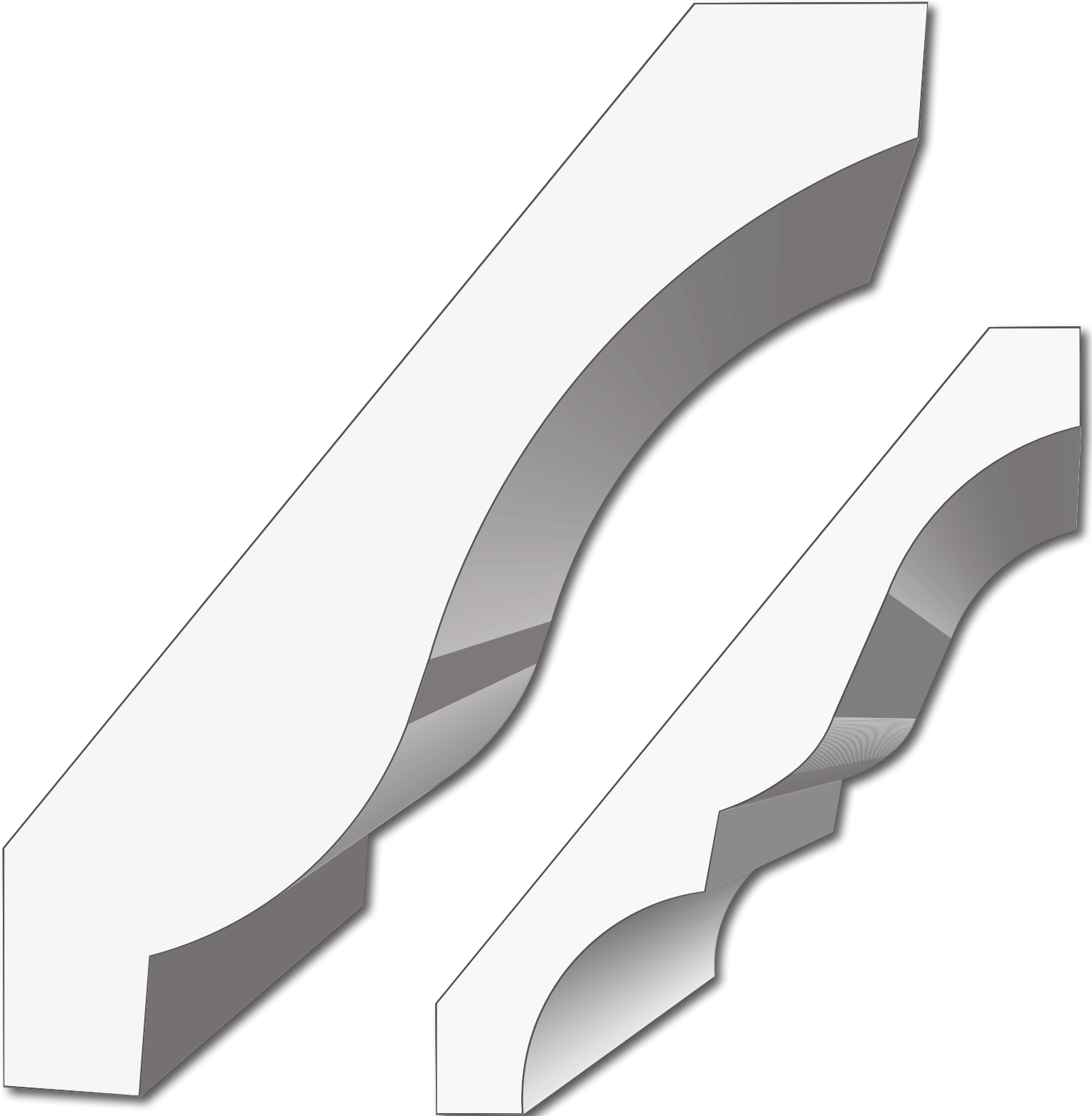

**TW 135**

1 7/8" x 10 1/2"

**TW 132**

1" x 7 1/2"





Tidewater Lumber  
& Moulding, Inc.

Greenville, South Carolina  
(864) 987-9663 | tidewaterlumberinc.com



CROWNS



**TW 138**  
1 1/16" x 4"

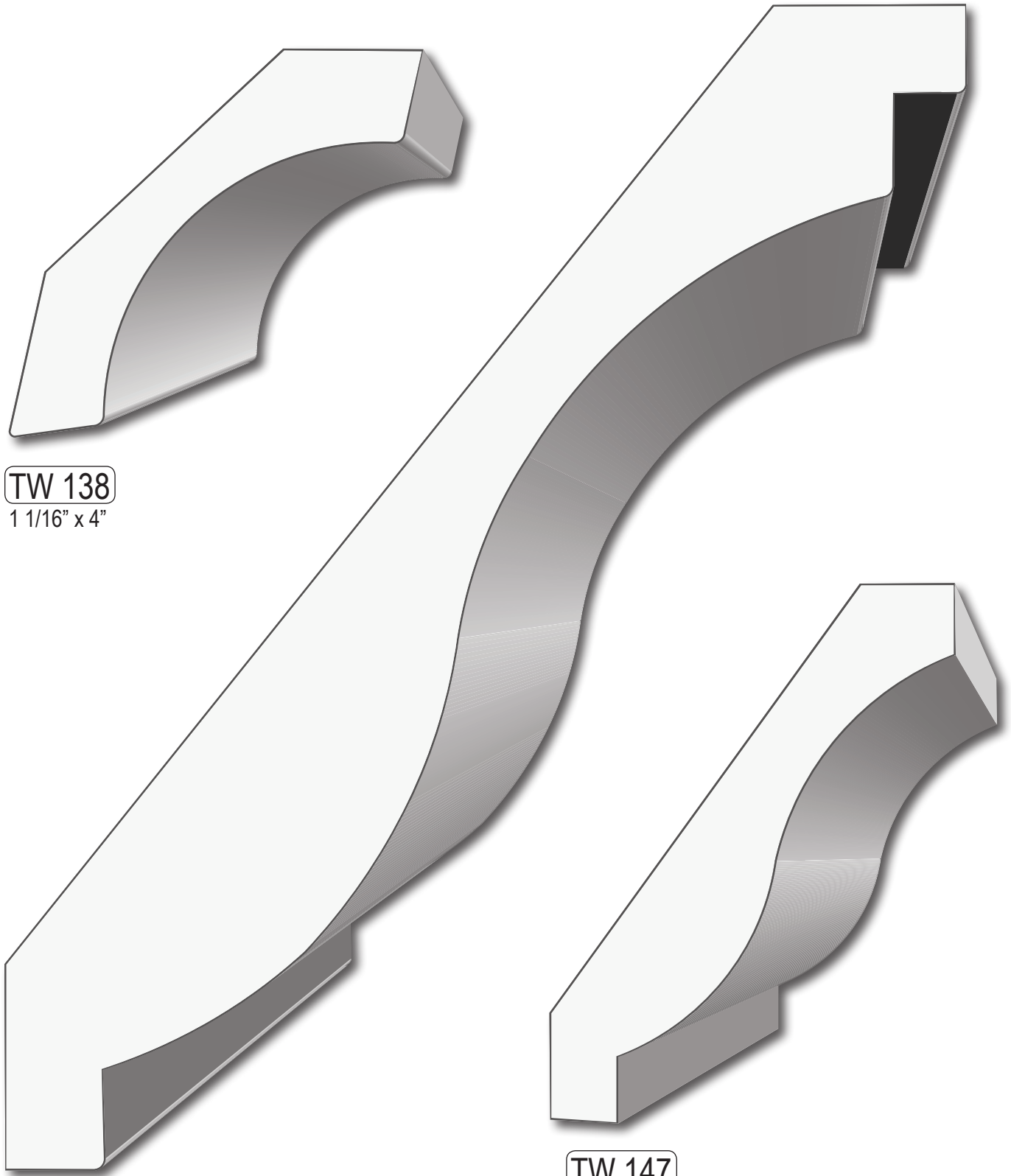

**TW 143**  
1 5/8" x 10 3/4"

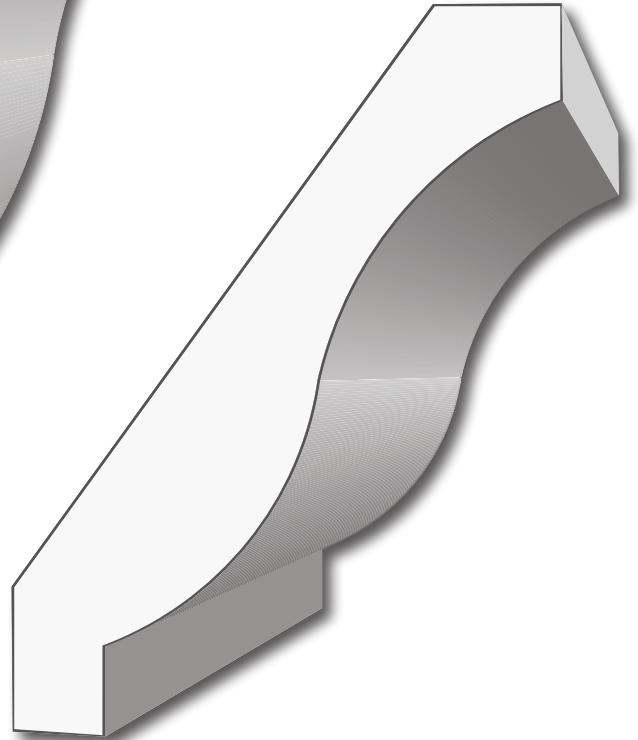

**TW 147**  
13/16" x 4 3/4"



Tidewater Lumber  
& Moulding, Inc.

Greenville, South Carolina  
(864) 987-9663 | tidewaterlumberinc.com



# CROWNS

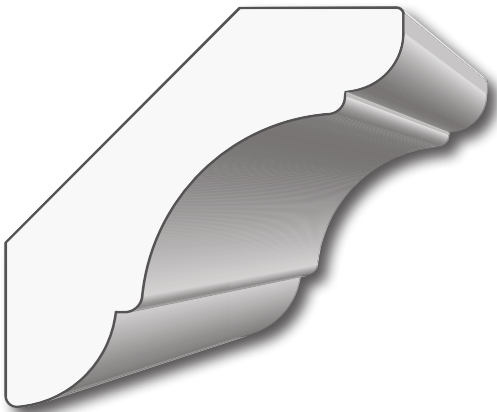

**TW 150**  
3/4" x 2 7/8"

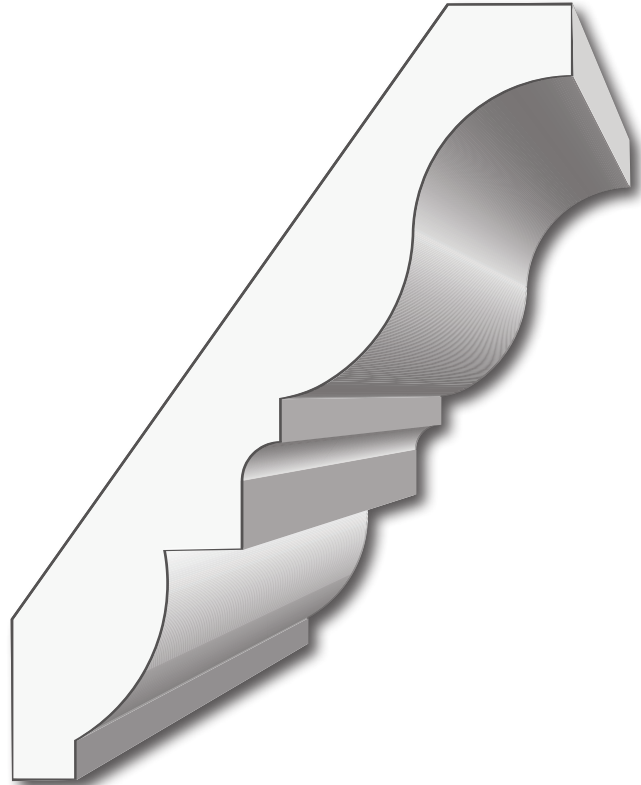

**TW 900**  
3/4" x 5"

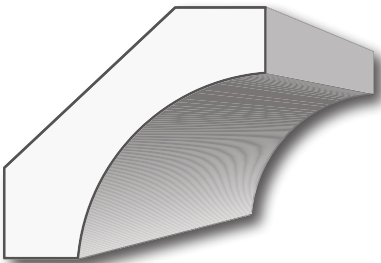

**TW 901**  
5/8" x 1 7/8"

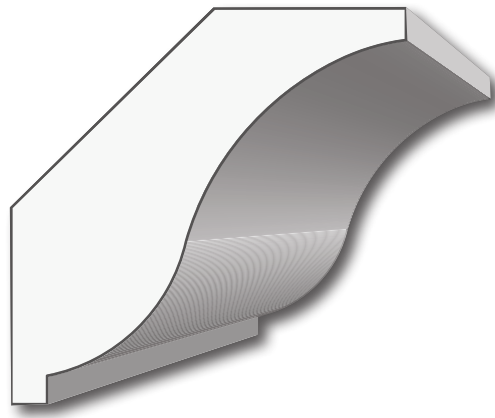

**TW 904**  
7/8" x 2 7/8"



Tidewater Lumber  
& Moulding, Inc.

Greenville, South Carolina  
(864) 987-9663 | tidewaterlumberinc.com



CROWNS

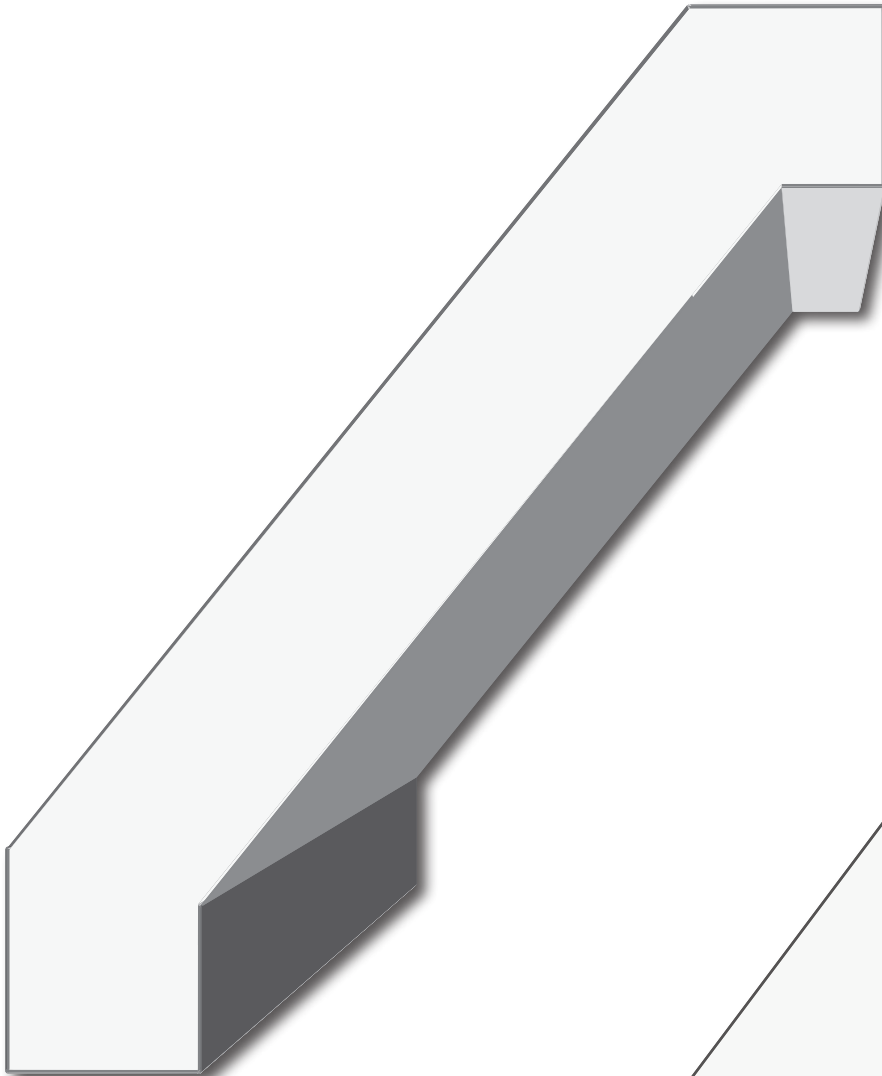

**TW 906**  
1 7/16" x 7 1/4"



**TW 909**  
1 1/4" x 6 7/8"



Tidewater Lumber  
& Moulding, Inc.

Greenville, South Carolina  
(864) 987-9663 | tidewaterlumberinc.com



# CROWNS

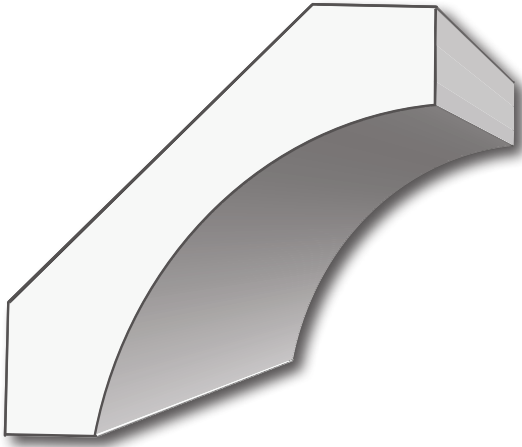

**TW 919**  
3/4" x 3 1/8"



**TW 920**  
3/4" x 4 1/4"

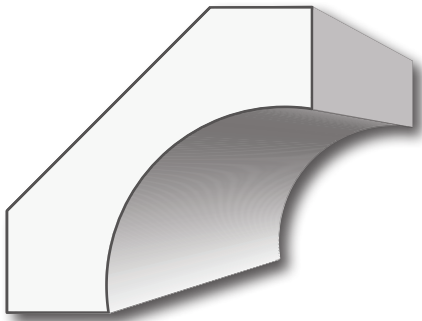

**TW 931**  
3/4" x 2 1/4"

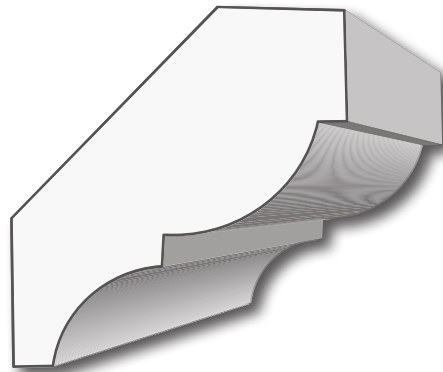

**TW 936**  
7/8" x 2 1/2"



Tidewater Lumber  
& Moulding, Inc.

Greenville, South Carolina  
(864) 987-9663 | tidewaterlumberinc.com



CROWNS

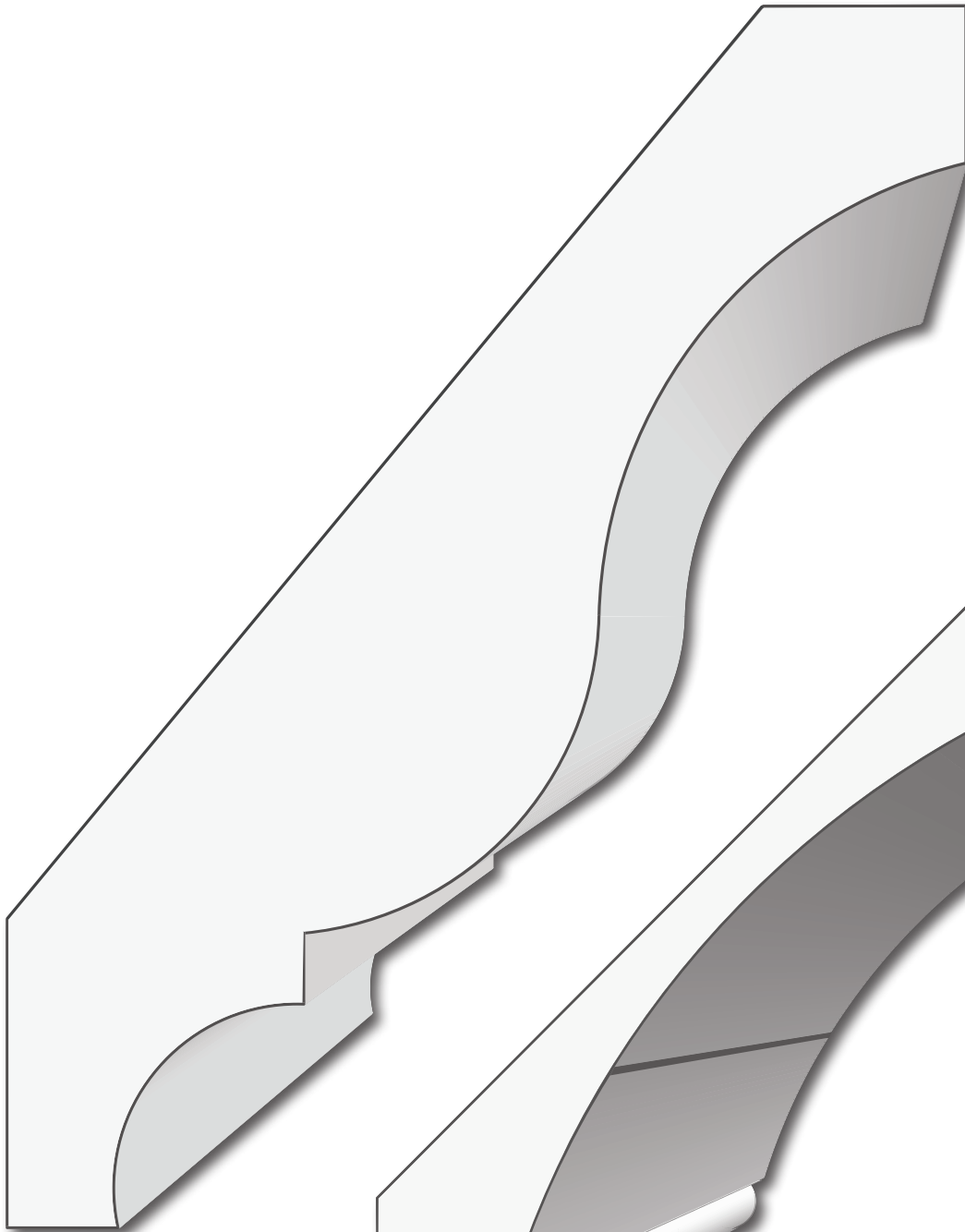

**TW 939**  
1 3/4" x 8 3/4"

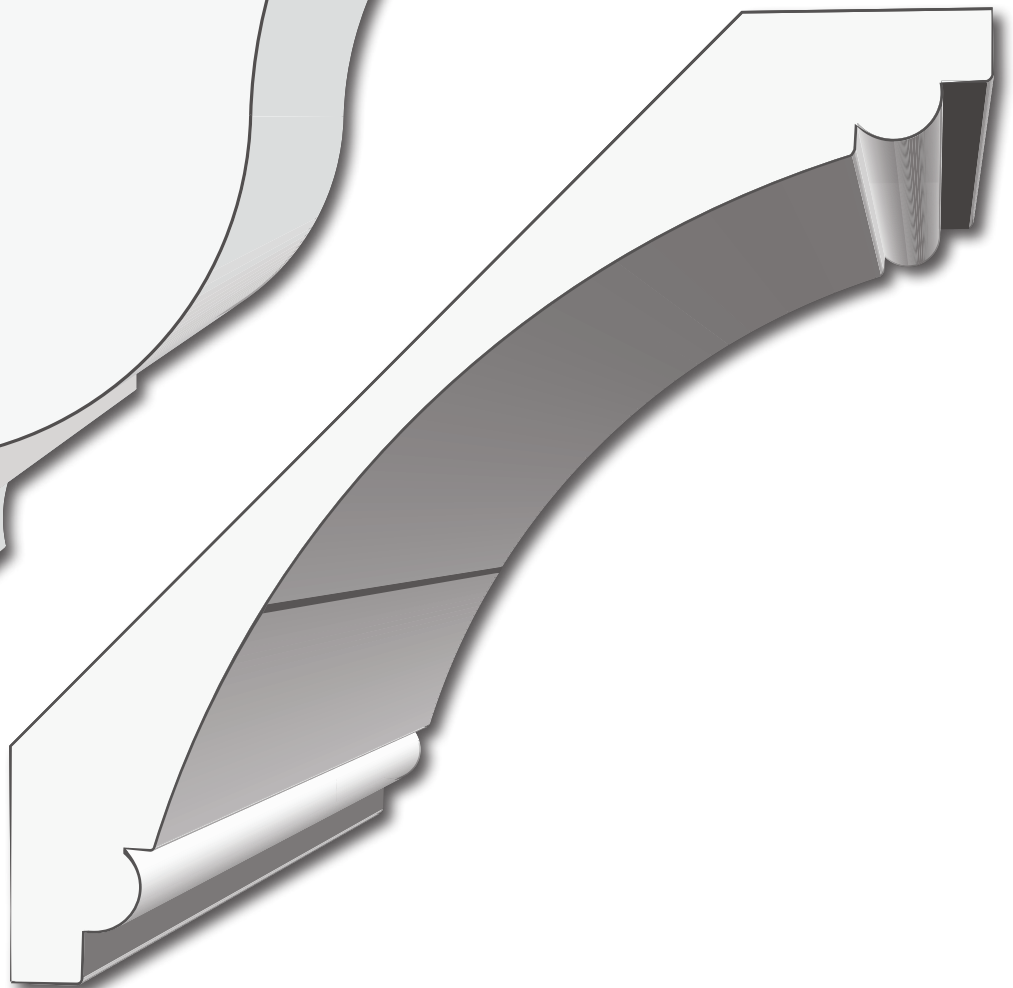

**TW 944**  
1 1/8" x 7 1/4"





Tidewater Lumber  
& Moulding, Inc.

Greenville, South Carolina  
(864) 987-9663 | tidewaterlumberinc.com



CROWNS

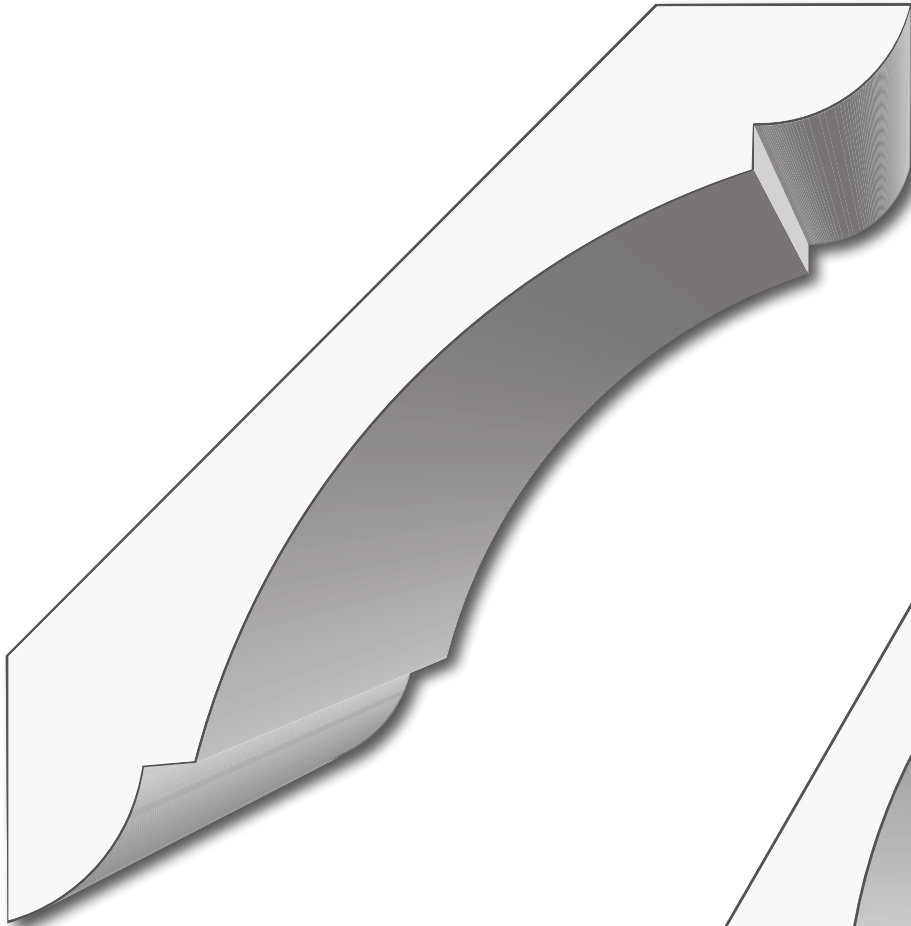

**TW 952**  
1" x 6 3/4"



**TW 955**  
1 1/4" x 7 1/4"



Tidewater Lumber  
& Moulding, Inc.

Greenville, South Carolina  
(864) 987-9663 | tidewaterlumberinc.com



## PICTURE MOULD

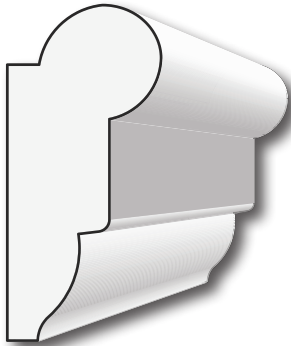

**TW 155**  
3/4" x 1 3/4"

---

## APRONS

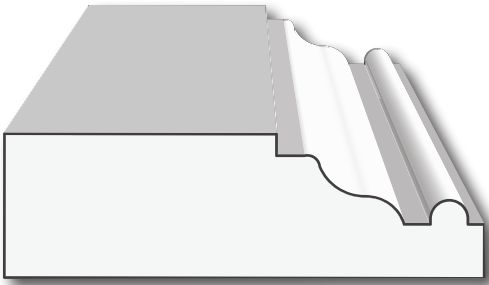

**TW 176**  
3/4" x 2 1/2"

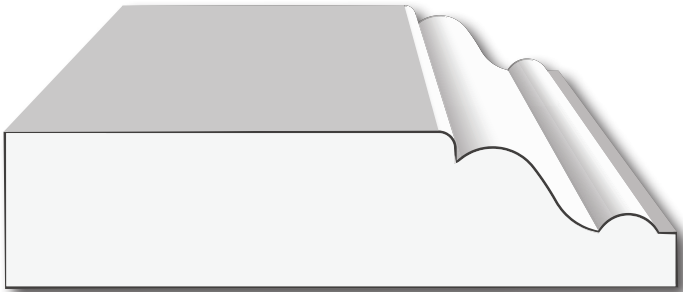

**TW 178**  
13/16" x 3 1/2"

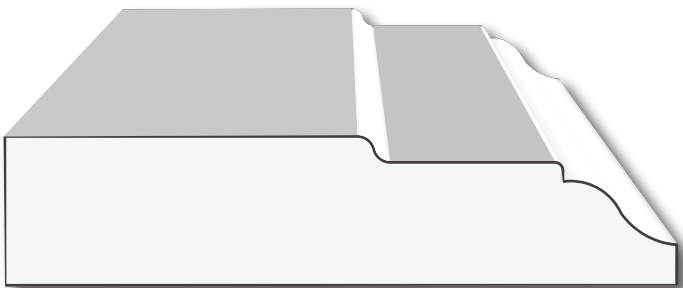

**TW 179**  
13/16" x 3 1/2"



Tidewater Lumber  
& Moulding, Inc.

Greenville, South Carolina  
(864) 987-9663 | tidewaterlumberinc.com



SPEED BASE

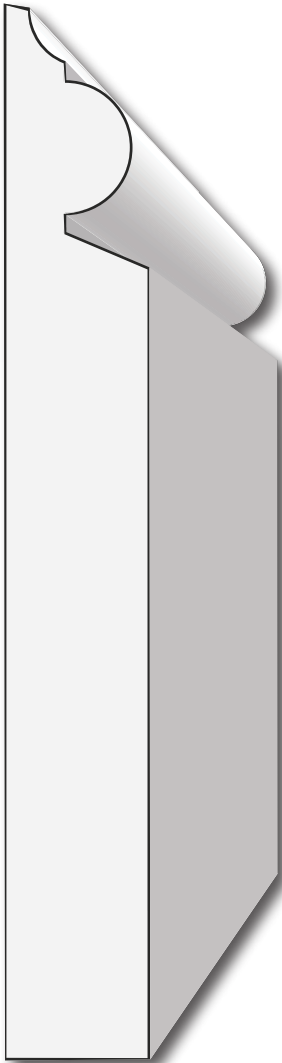

**TW 181**  
3/4" x 5 1/2"

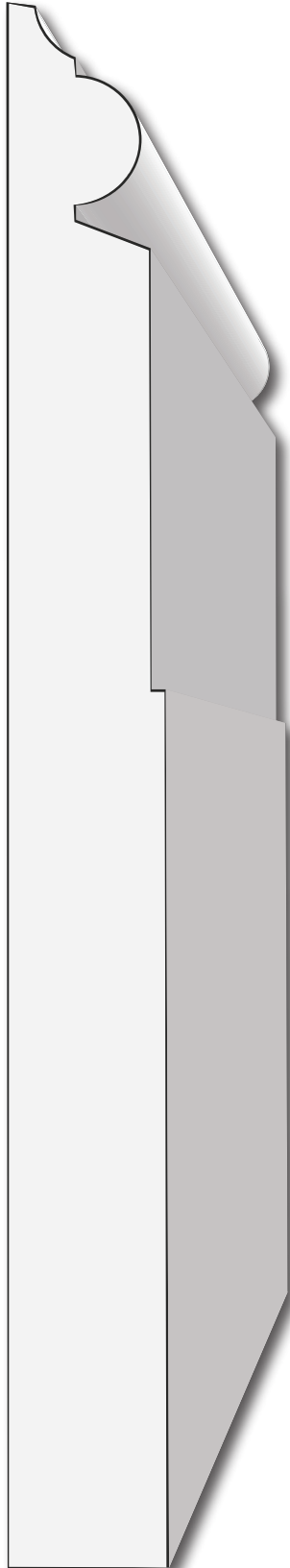

**TW 183-S**  
7/8" x any height

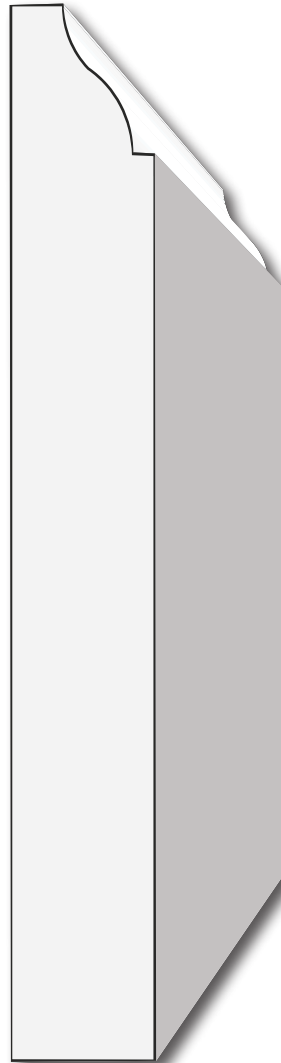

**TW 186**  
3/4" x 5 1/2"

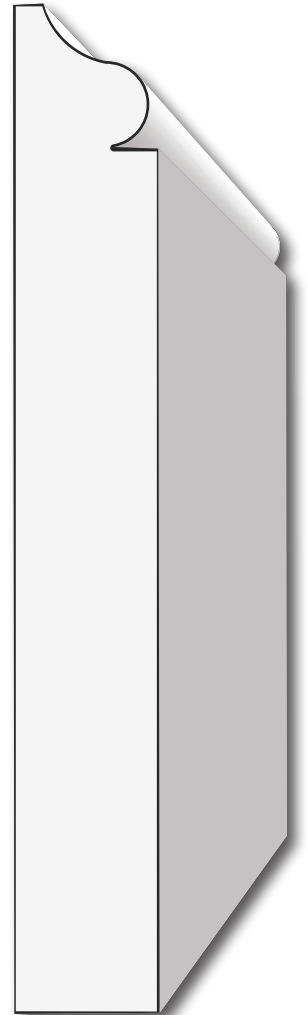

**TW 190**  
3/4" x 5 1/4"



Tidewater Lumber  
& Moulding, Inc.

Greenville, South Carolina  
(864) 987-9663 | tidewaterlumberinc.com



SPEED BASE

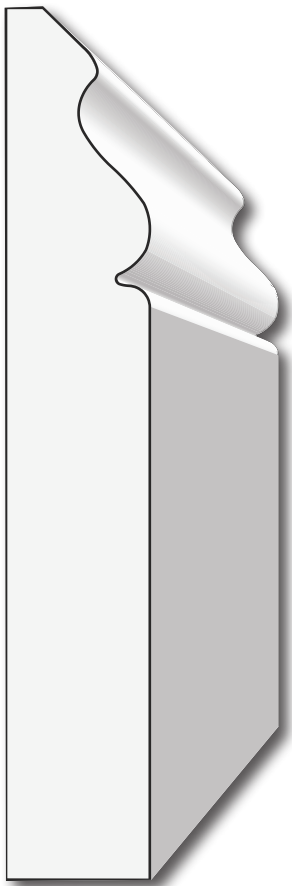

**TW 199**

3/4" x 3 1/4"  
to 8 1/4"

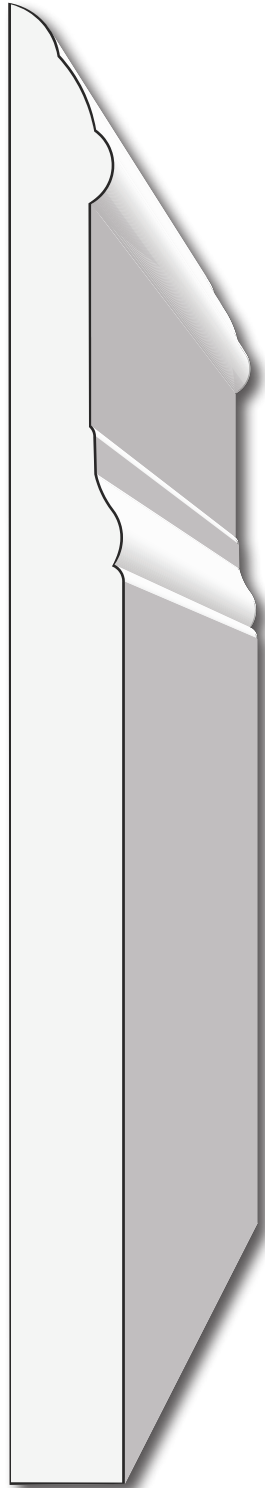

**TW 1108**

19/32" x any height

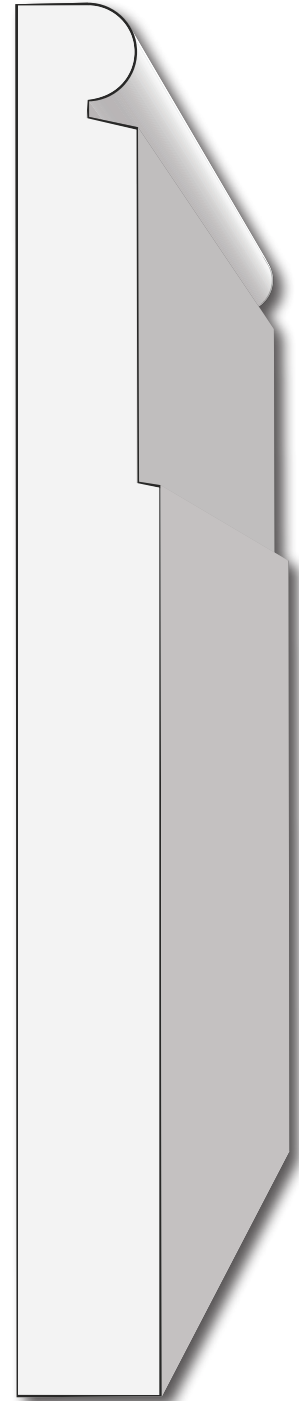

**TW 1109**

3/4" x any height



Tidewater Lumber  
& Moulding, Inc.

Greenville, South Carolina  
(864) 987-9663 | tidewaterlumberinc.com



# BASE CAPS



**TW 202**

1" x 1 5/8"



**TW 204**

5/8" x 3/4"



**TW 210**

3/4" x 1 3/8"



**TW 205**

3/4" x 1 3/8"



Tidewater Lumber  
& Moulding, Inc.

Greenville, South Carolina  
(864) 987-9663 | tidewaterlumberinc.com



# CHAIR RAILS



**TW 250**  
3/4" x 2 1/2"

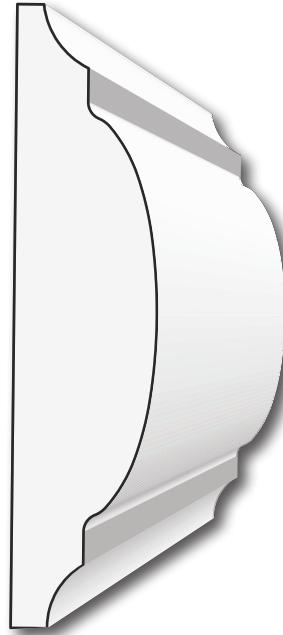

**TW 253**  
3/4" x 3 1/4"

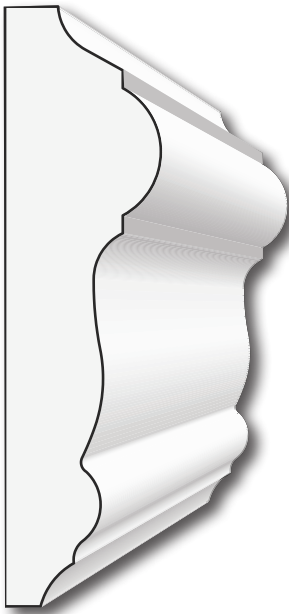

**TW 254**  
13/16" x 3 1/8"

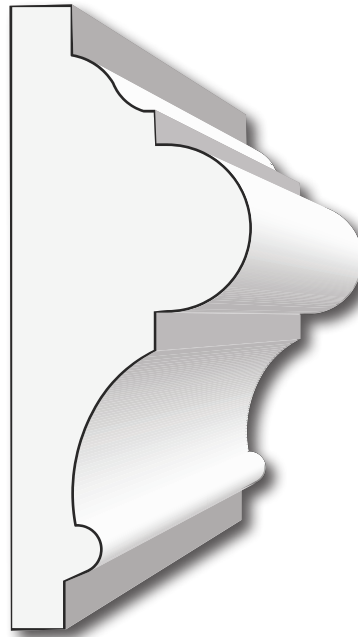

**TW 256**  
1 1/4" x 3 1/4"





Tidewater Lumber  
& Moulding, Inc.

Greenville, South Carolina  
(864) 987-9663 | tidewaterlumberinc.com



## CHAIR RAILS

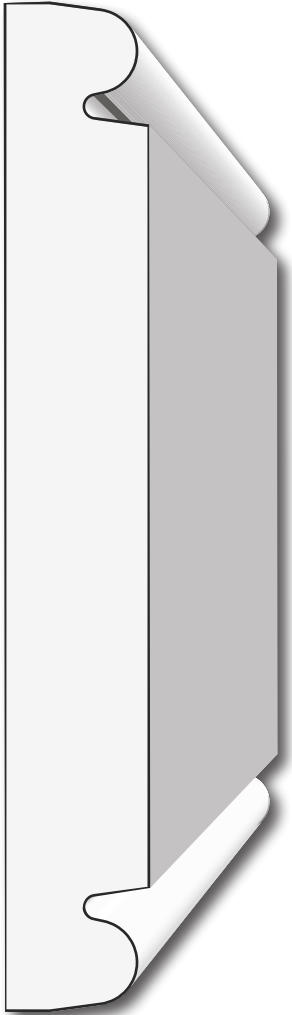

**TW 264**  
3/4" x 5 1/4"

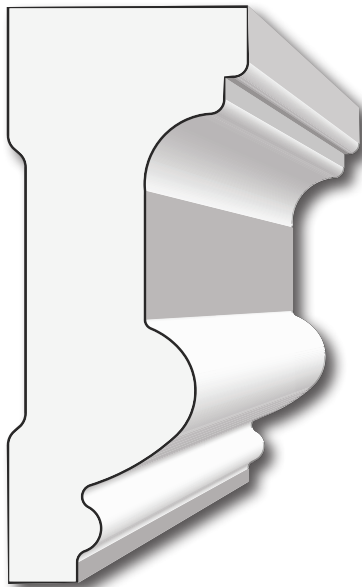

**TW 258**  
1 1/4" x 3"



**TW 263**  
7/8" x 2 1/4"



Tidewater Lumber  
& Moulding, Inc.

Greenville, South Carolina  
(864) 987-9663 | tidewaterlumberinc.com



## CHAIR RAILS

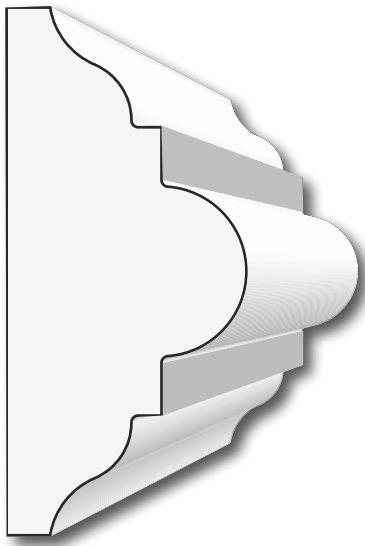

**TW 265**

1 1/4" x 2 3/4"

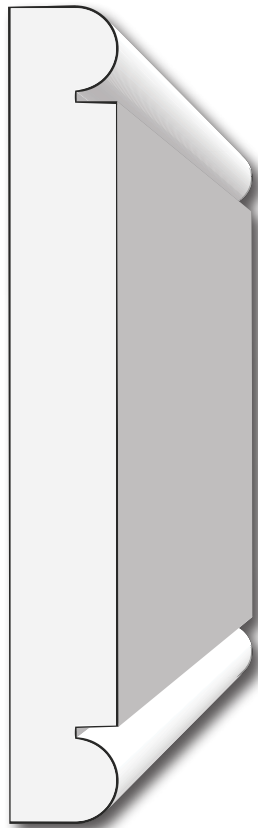

**TW 276**

9/16" x 4 1/4"

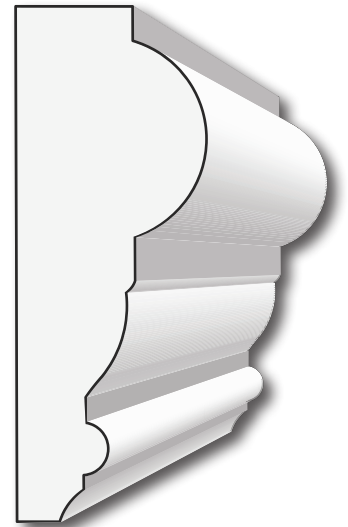

**TW 277**

1" x 2 11/16"



Tidewater Lumber  
& Moulding, Inc.

Greenville, South Carolina  
(864) 987-9663 | tidewaterlumberinc.com



## CHAIR RAILS



**TW 280**  
1" x 4"

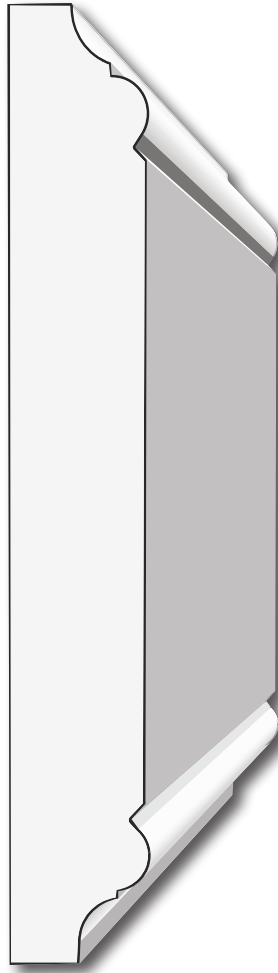

**TW 282**  
3/4" x 5"

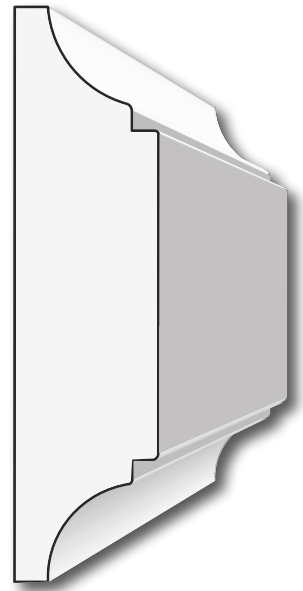

**TW 286**  
3/4" x 3"



Tidewater Lumber  
& Moulding, Inc.

Greenville, South Carolina  
(864) 987-9663 | tidewaterlumberinc.com



## APPLIED MOULDS



**TW 334**  
7/16" x 13/16"

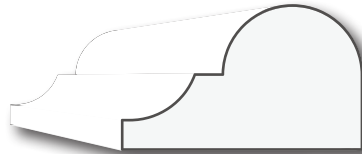

**TW 338**  
3/4" x 1 1/4"



**TW 340**  
7/8" x 2 1/4"



**TW 341**  
3/4" x 1 1/8"

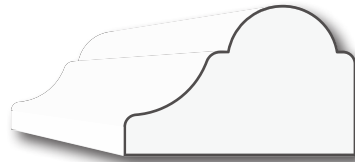

**TW 342**  
3/4" x 1 1/4"



**TW 351**  
1 1/16" x 2 1/8"



**TW 360**  
3/4" x 1 5/8"



**TW 366**  
5/8" x 1 5/8"

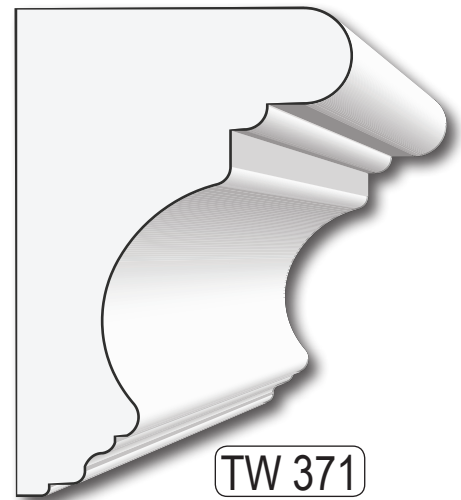

**TW 371**  
1 3/4" x 2 1/2"



Tidewater Lumber  
& Moulding, Inc.

Greenville, South Carolina  
(864) 987-9663 | tidewaterlumberinc.com



# APPLIED MOULDS

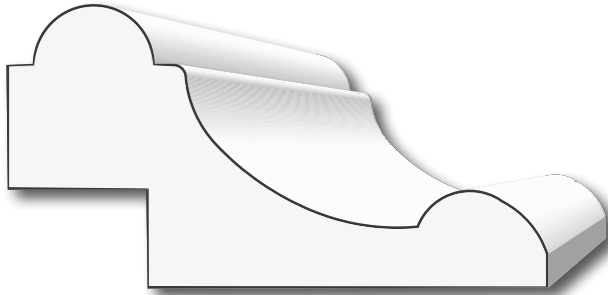

**TW 372**  
1 1/2" x 2 7/8"

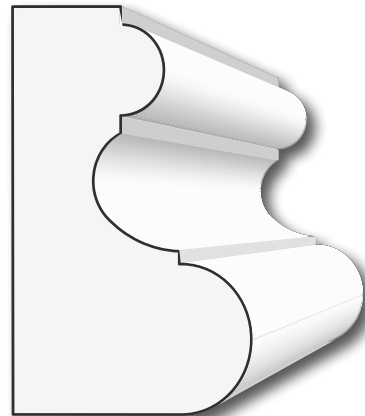

**TW 375**  
1 1/4" x 2 1/8"

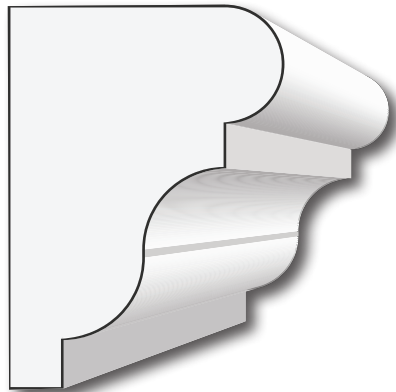

**TW 384**  
1 7/16" x 2"

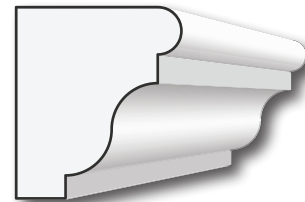

**TW 385**  
7/8" x 1"

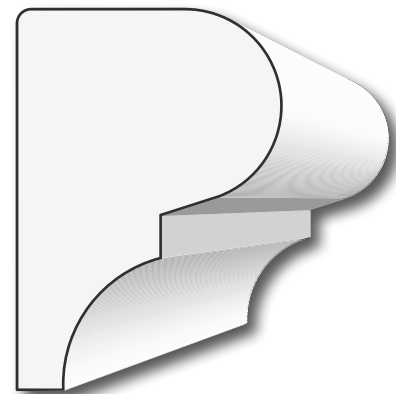

**TW 388**  
1 3/8" x 2"

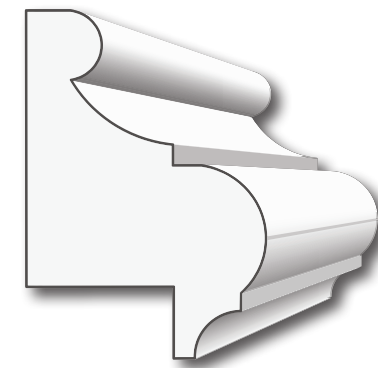

**TW 392**  
1 1/4" x 2 13/16"



Tidewater Lumber  
& Moulding, Inc.

Greenville, South Carolina  
(864) 987-9663 | tidewaterlumberinc.com



## APPLIED MOULDS

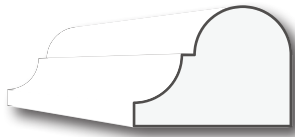

**TW 395**  
5/8" x 13/16"

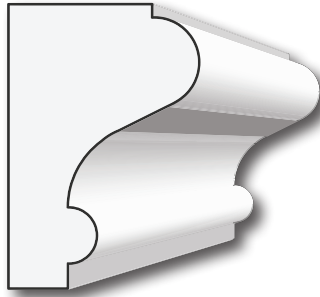

**TW 804**  
1" x 1 1/2"

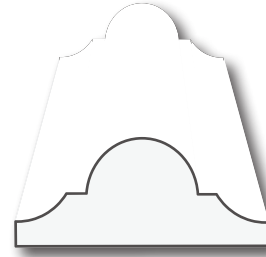

**TW 818**  
9/16" x 1 5/16"

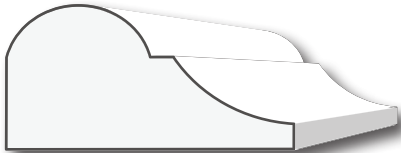

**TW 821**  
1 1/2" x 3/4"

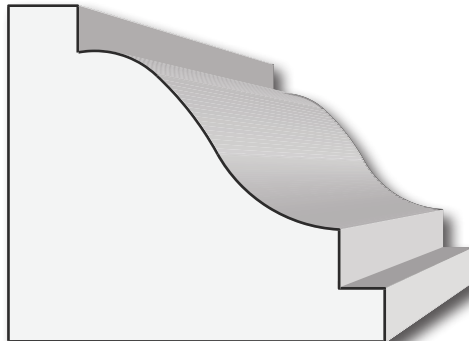

**TW 826**  
1 3/4" x 2"

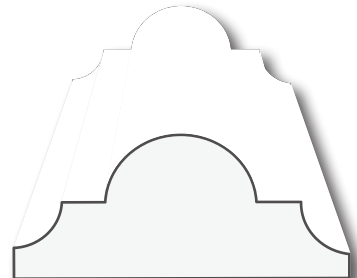

**TW 828**  
3/4" x 1 3/4"



**TW 836**  
1 7/8" x 3 1/2"





Tidewater Lumber  
& Moulding, Inc.

Greenville, South Carolina  
(864) 987-9663 | tidewaterlumberinc.com



## WINDOW PARTS



**TW 402**

1 1/16" x 3 1/2"

1 1/16" x 5 1/2"



**TW 404**

3/4" x 3 1/4" (or any width)



Tidewater Lumber  
& Moulding, Inc.

Greenville, South Carolina  
(864) 987-9663 | tidewaterlumberinc.com



# HAND RAILS

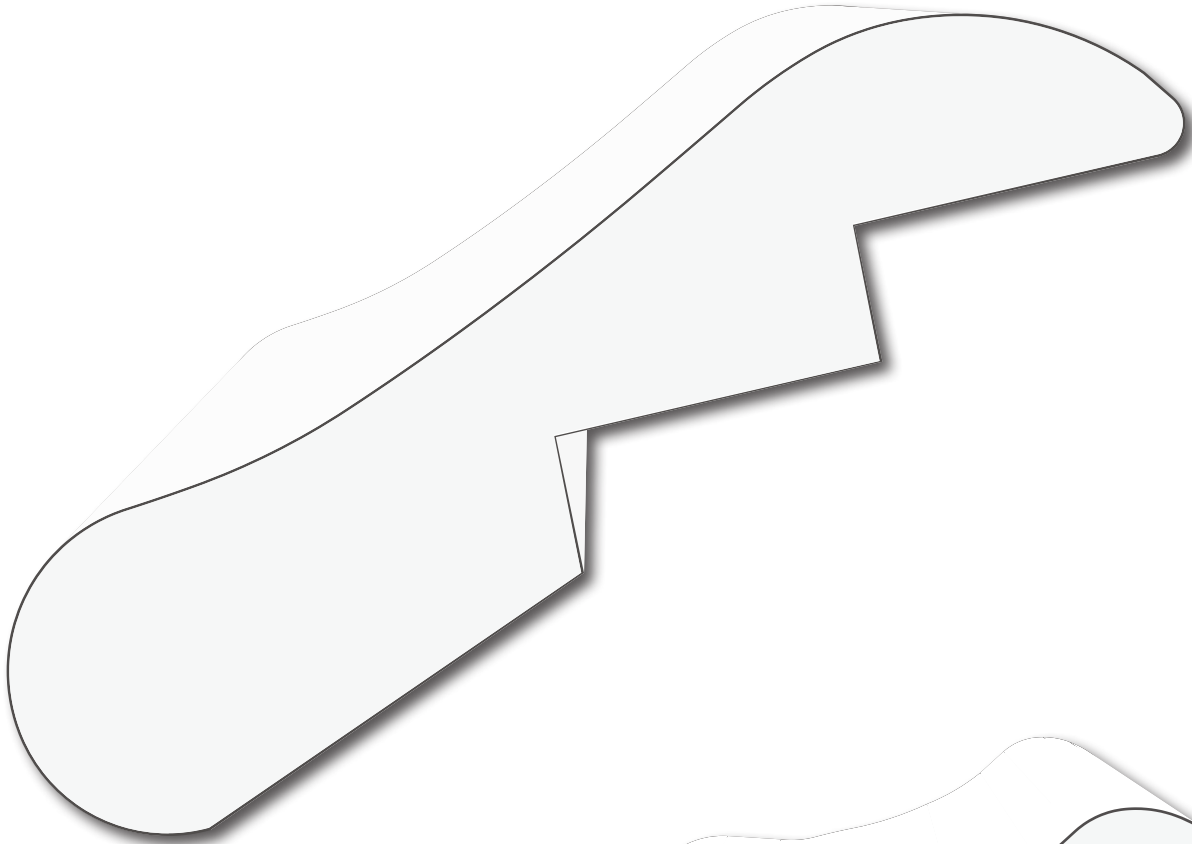

**TW 428**  
1 5/8" x 6 7/8"

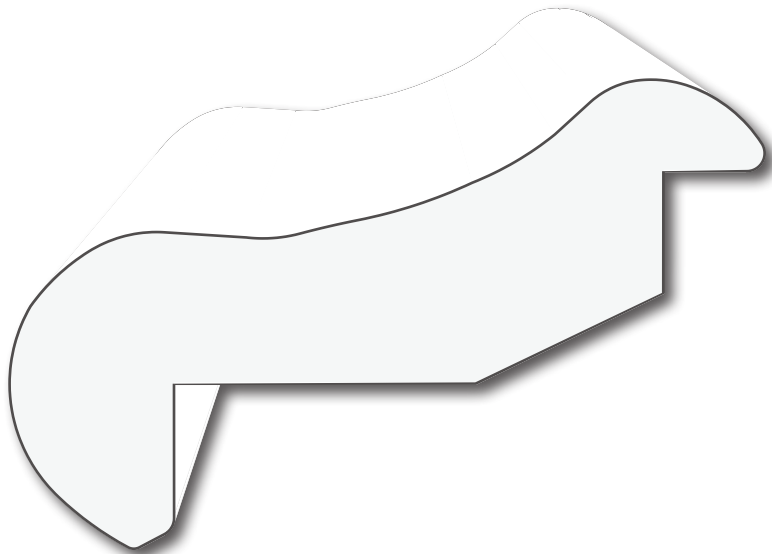

**TW 432**  
1 1/2" x 4 1/8"



Tidewater Lumber  
& Moulding, Inc.

Greenville, South Carolina  
(864) 987-9663 | tidewaterlumberinc.com



MANTLE MOULD

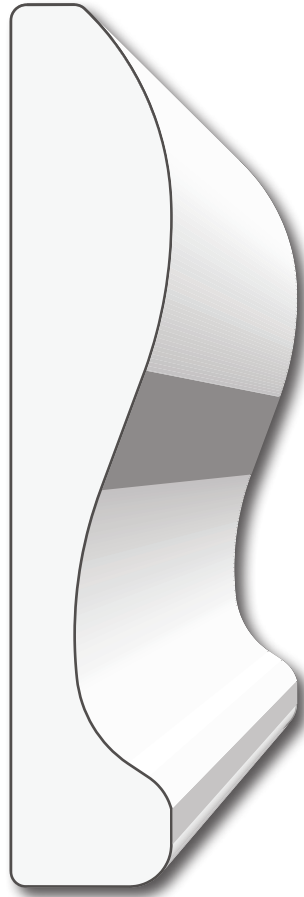

**TW 453**

13/16" x 4 9/16"



# Tidewater Lumber & Moulding, Inc.

Greenville, South Carolina  
(864) 987-9663 | tidewaterlumberinc.com



## FLOORING

Tidewater mills the highest quality lumber from around the world, producing authentic plank floors. A plank floor is wider in width and longer in length than a strip floor (which is 2 1/4" and only 6" - 7' in length). Tidewater's floors are so long, that the ends are squared but do not need to be end matched.

Most homes built today have such large rooms that the wider floors are actually more proportionate to the scale of the rooms. Our floors are 3/4" thick and are 3", 4", 5", and 6" wide. The lengths range from 2' - 16'. All floors are grooved on the back to help prevent cupping. The lumber is kiln dried to 6-9% moisture content.

We offer two grades of flooring. The first is Rustic, which will have tight knots and more color variation - such as mineral streaking. The second is Select, which is milled from the highest grade of lumber available. Select Flooring will have very few knots, if any, and more consistent color.

### STOCK

- |                          |                          |
|--------------------------|--------------------------|
| Am. Cherry - Select      | Hickory - Select         |
| Am. Cherry - Rustic      | Hickory - Rustic         |
| Ant. Heart Pine - Rustic | Red Oak - Select         |
| Ant. Heart Pine - #1     | Red Oak - Rustic         |
| Ant. Heart Pine - Select | Sassafras - Wormy        |
| Ash - Select             | White Oak - Select       |
| Ash - Rustic             | White Oak - Rustic       |
| Brazilian Cherry 3"      | Walnut - Select          |
| Brazilian Cherry 5"      | Walnut - Rustic          |
| Cumaru                   | Wormy Oak - Rustic       |
| Hard Maple               | Circle Sawn Oak - Rustic |
| Locust                   |                          |

Skirt Boards: 3/4" x 11 1/4" S4S  
Risers: 3/4" x 7 1/4"



Maple plank



Brazilian cherry plank



**TW 500**

1/2" x 3/4"  
(Shoe Mould)



**TW 502**

3/4" x 3/4"  
(Quarter Round)



**TW 504**

5/16" x 1 1/2"  
(Baby Threshold)



# Tidewater Lumber & Moulding, Inc.

Greenville, South Carolina  
(864) 987-9663 | tidewaterlumberinc.com



## FLOORING



**TW 505**  
5/8" x 1 7/8"  
(T-Mould)

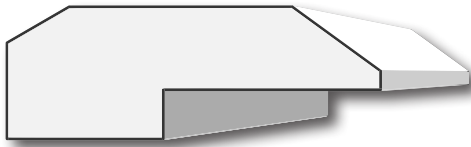

**TW 506**  
1 1/16" x 2"  
(Threshold)



**TW 507**  
1 3/16" x 2 1/4"  
(Reducer)



Circle sawn oak

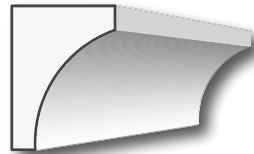

**TW 513**  
9/16" x 3/4"  
(Stair Cove Mould)

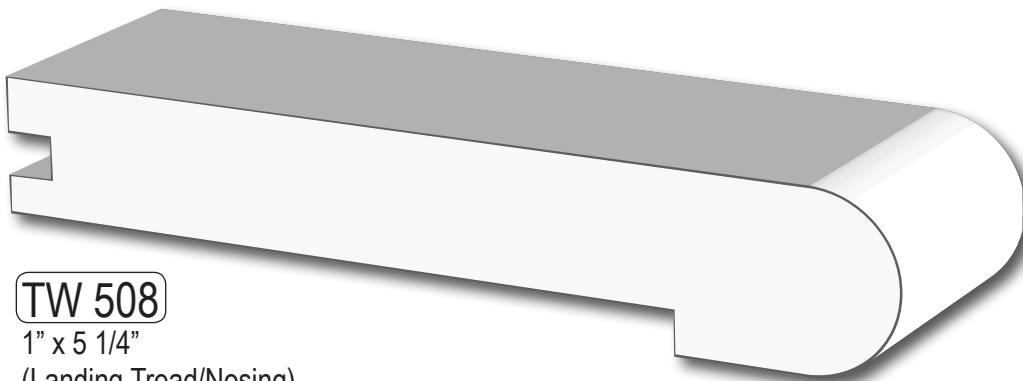

**TW 508**  
1" x 5 1/4"  
(Landing Tread/Nosing)



Tidewater Lumber & Moulding, Inc.

Greenville, South Carolina  
(864) 987-9663 | tidewaterlumberinc.com



# PANELING



Cypress paneling

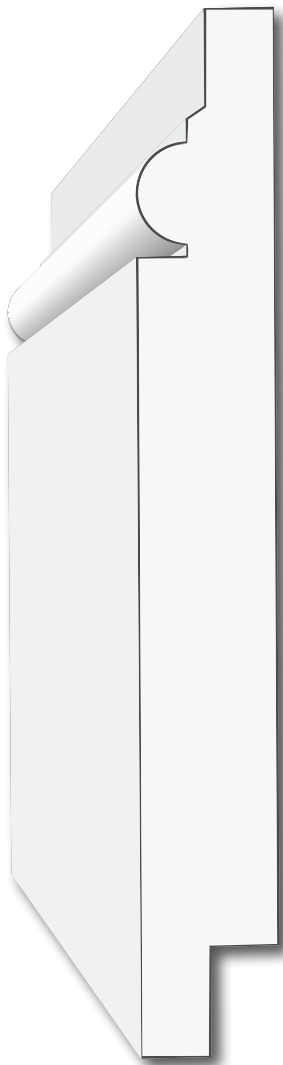

**TW 601**  
3/4" x 5 1/2", 7 1/4"

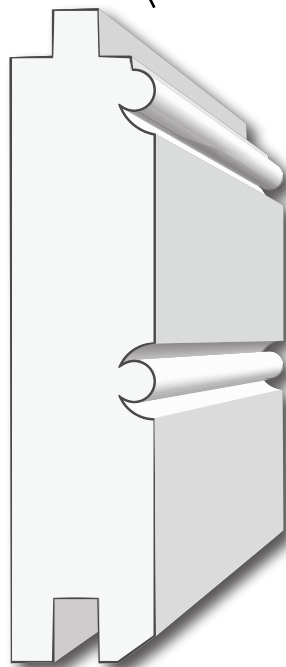
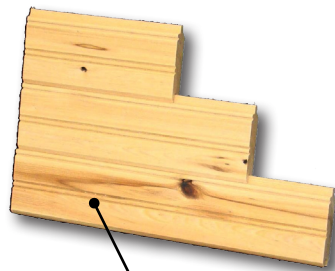

**TW 602**  
3/4" x 3 3/8"

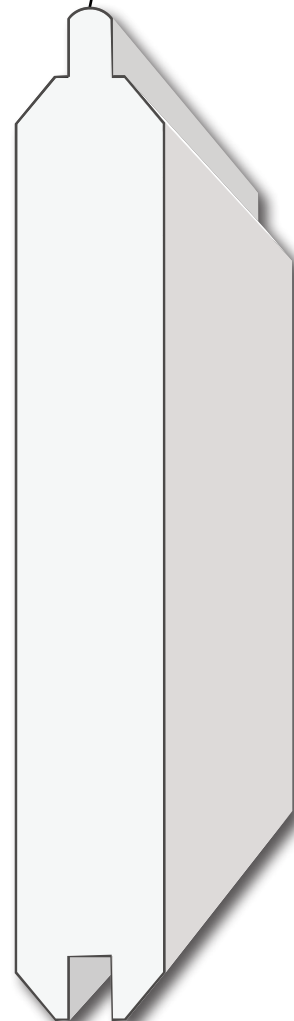

**TW 603**  
3/4" x 5 1/4"





Tidewater Lumber & Moulding, Inc.

Greenville, South Carolina  
(864) 987-9663 | tidewaterlumberinc.com



# PANELING

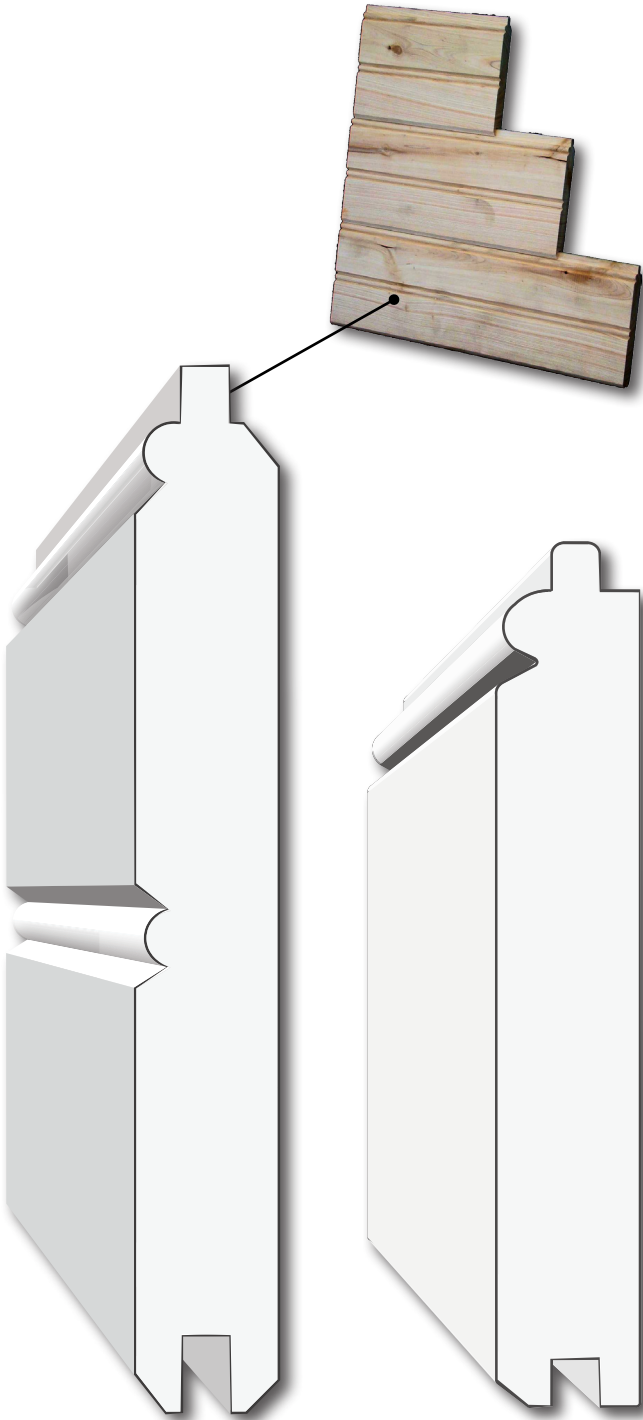

**TW 605**  
3/4" x 5 1/2"

**TW 609**  
3/4" x 4 1/2"

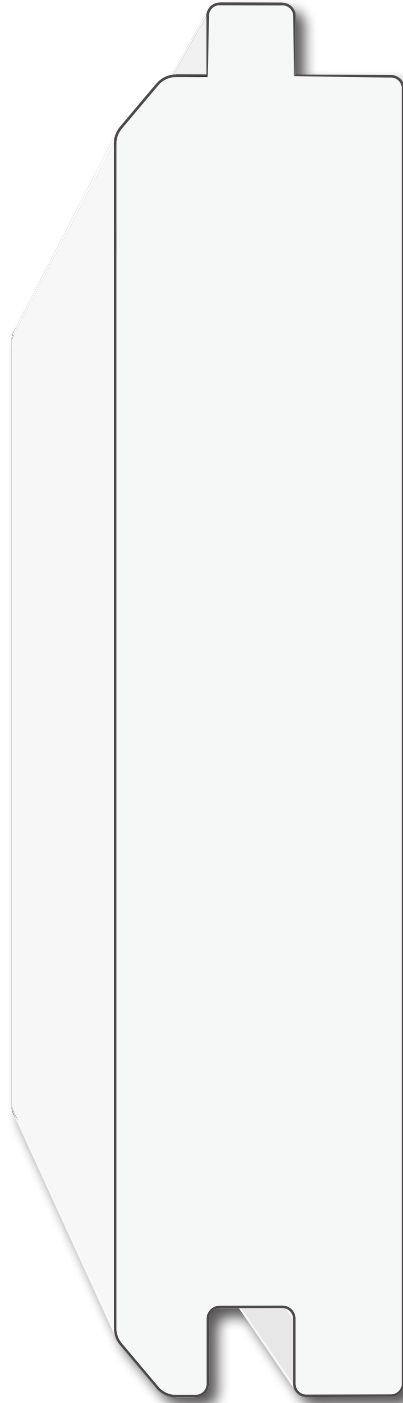

**TW 610**  
1 1/2" x 7 1/4"

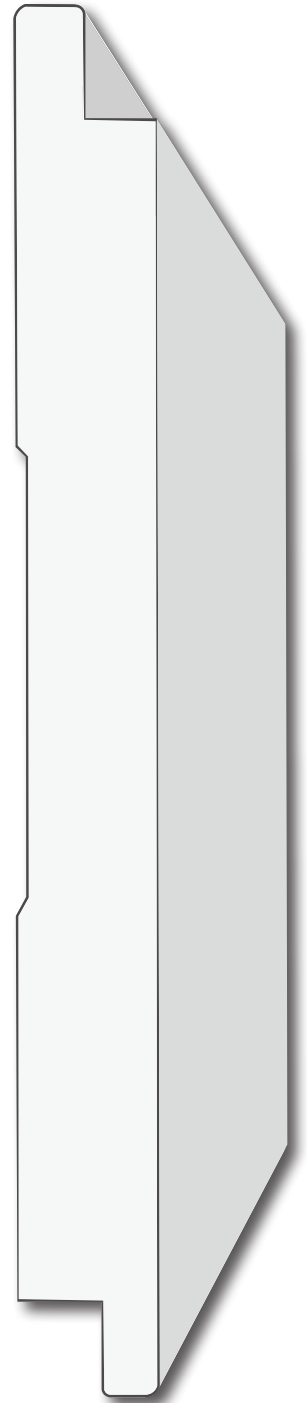

**TW 616**  
3/4" x 7 1/4"  
(Ship Lap)



Tidewater Lumber  
& Moulding, Inc.

Greenville, South Carolina  
(864) 987-9663 | tidewaterlumberinc.com



SIDING

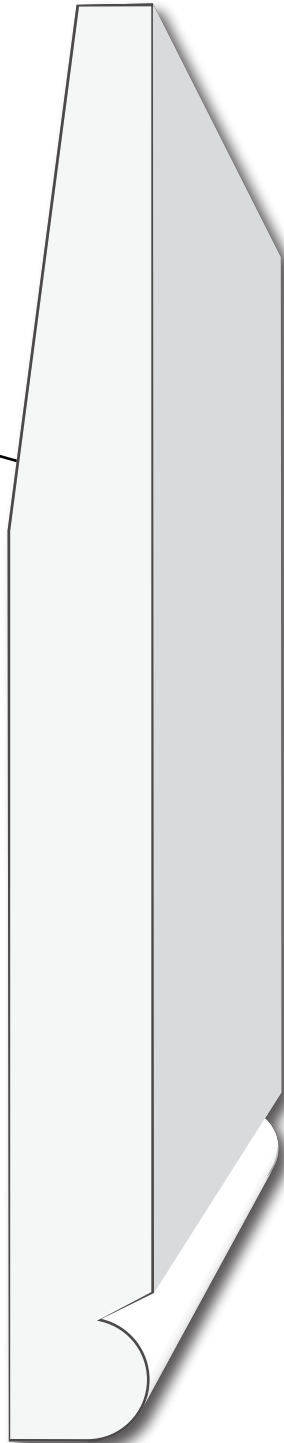

**TW 625**

3/4" x 5 1/2",  
7 1/4", 9 1/4"

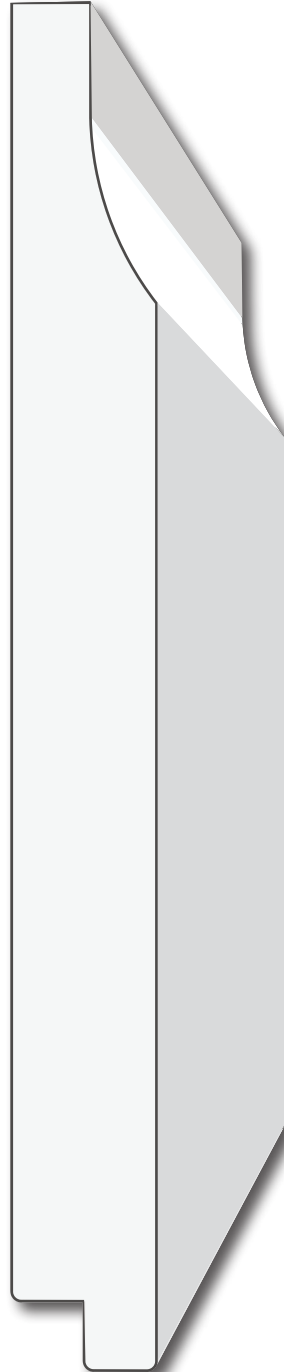

**TW 628 B**

3/4" x 7 1/8"  
(rough or smooth face)



Tidewater Lumber  
& Moulding, Inc.

Greenville, South Carolina  
(864) 987-9663 | tidewaterlumberinc.com



SIDING

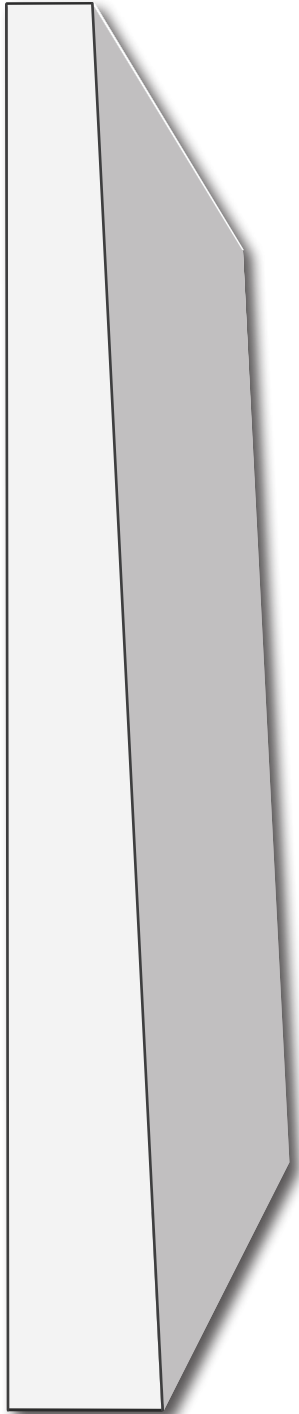

**TW 629**

3/4" x 5 1/2"

3/4" x 7 1/4"

Beveled Siding

(rough or smooth face)

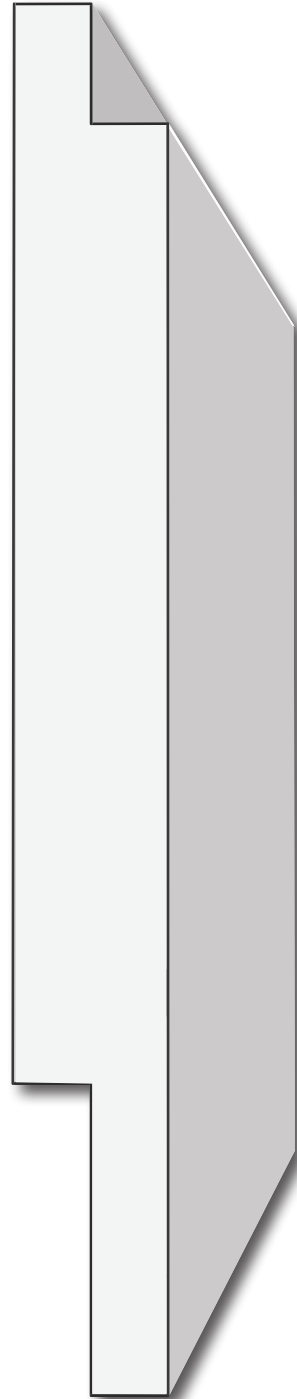

**TW 630**

13/16" x any spec. width

(rough or smooth face)



Tidewater Lumber  
& Moulding, Inc.

Greenville, South Carolina  
(864) 987-9663 | tidewaterlumberinc.com



# PLINTHBLOCKS



**TW 700**

2" x 5"

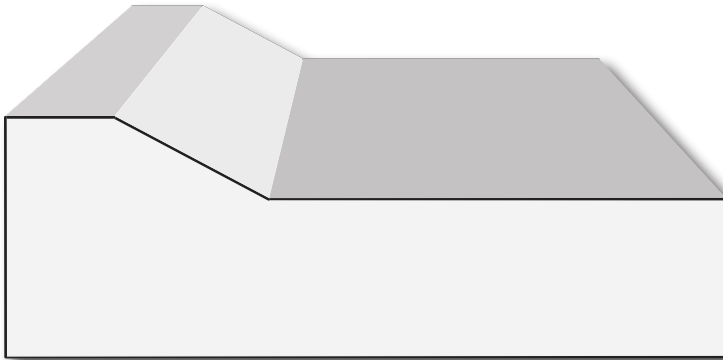

**TW 703**

1 1/4" x 3 3/4"

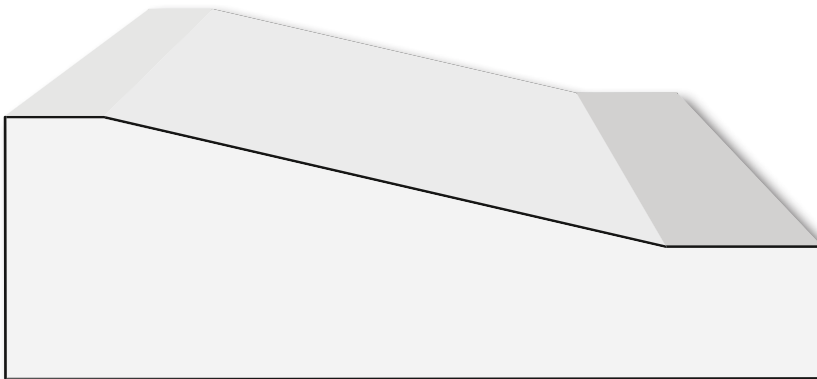

**TW 704**

1 3/8" x 4 1/4"



Tidewater Lumber  
& Moulding, Inc.

Greenville, South Carolina  
(864) 987-9663 | tidewaterlumberinc.com



# PLINTHBLOCKS



**TW 706** Modified  
2 1/16" x 5 3/4"

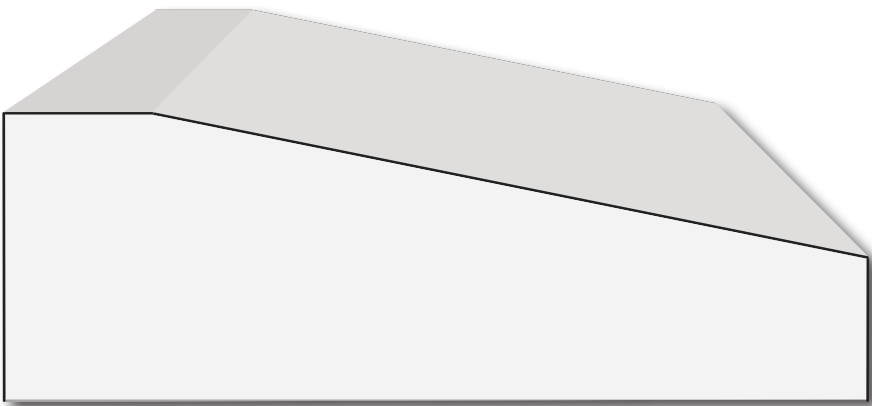

**TW 707**  
1 1/2" x 4 1/2"



Tidewater Lumber  
& Moulding, Inc.

Greenville, South Carolina  
(864) 987-9663 | tidewaterlumberinc.com



# QUARTER ROUNDS

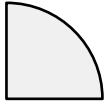

1/2"

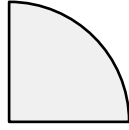

5/8"

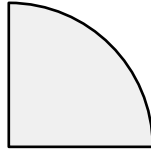

3/4"

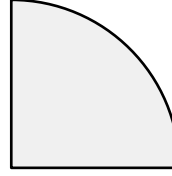

7/8"

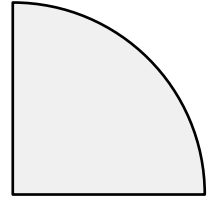

1"

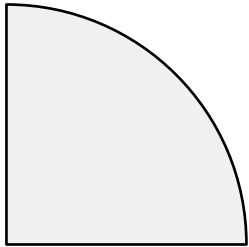

1 1/4"

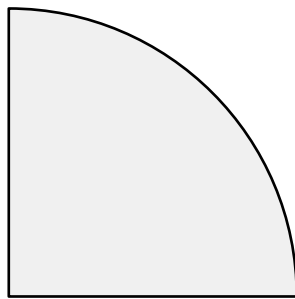

1 1/2"

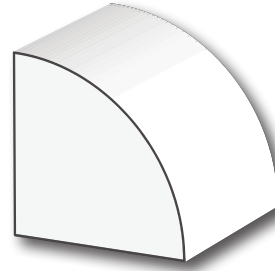

# COVES



1/2" x 1/2"

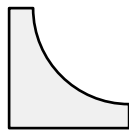

5/8" x 5/8"

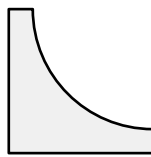

3/4" x 3/4"

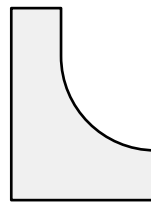

3/4" x 1"

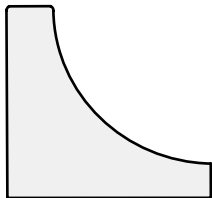

1 1/16" x 1"

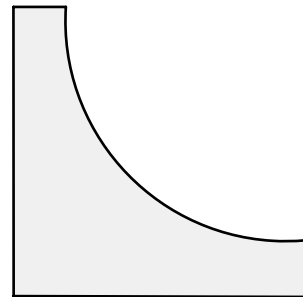

1 1/2" x 1 1/2"

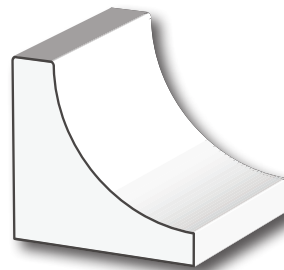





Tidewater Lumber  
& Moulding, Inc.

Greenville, South Carolina  
(864) 987-9663 | tidewaterlumberinc.com



# HALF ROUNDS



1/2"



3/8" X 3/4"

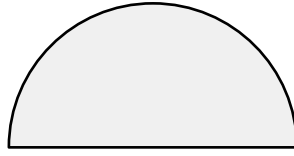

3/4"

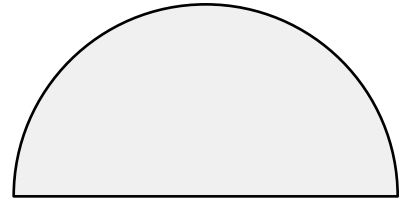

1" x 2"

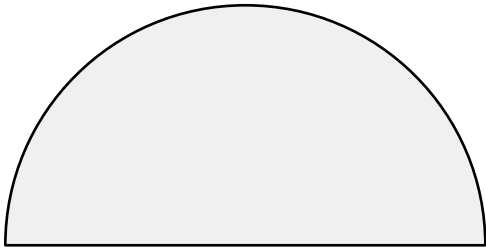

1 1/4" x 2 1/2"

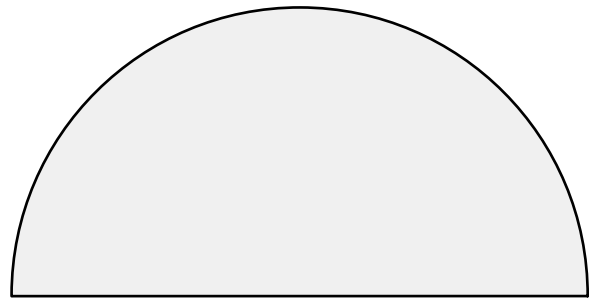

1 1/2" x 3"

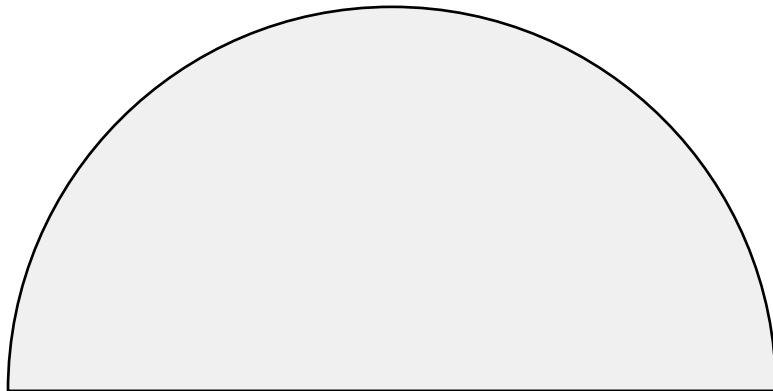

2" x 4"





# Tidewater Lumber & Moulding, Inc.

Greenville, South Carolina  
(864) 987-9663 | tidewaterlumberinc.com



## DECKING

### WHAT IS IPE?

Tidewater Lumber and Moulding supplies Brazilian Ipe decking. Ipe is a South American Hardwood, and when we say hard - we mean HARD! It has a Janka Hardness Rating of 3,684. In comparison, red oak is rated 1,290. Cedar is rated 900. Ipe is estimated by the U.S. Forest Laboratory to last 25 years or more. It is rated Class B by the NFPA and is resistant to fire and insect infestation. There are virtually no knots or defects in the decking boards. If it is oiled once a year, it will maintain a rich, warm color. If it is not oiled, Ipe will weather to a beautiful silver gray, much like teak furniture.

### ACCESSORIES

D-MEZ	Memzers
D-SS214	Stainless Steel Screws (1 Box = 100 sq. ft.) 2 1/4"
D-SS158	Stainless Steel Screws (1 Box = 100 sq. ft.) 1 5/8"
D-EW	End Wax (1 Quart)
D-DM100	Deckmaster 100 Pack (covers 250 sq. ft.)
D-DM10	Deckmaster 10 Pack (covers 25 sq. ft.)



Ipe decking



# Tidewater Lumber & Moulding, Inc.

Greenville, South Carolina  
(864) 987-9663 | tidewaterlumberinc.com



## DECKING



1 x 4 Ipe Decking  
(3/4" x 3 1/2")

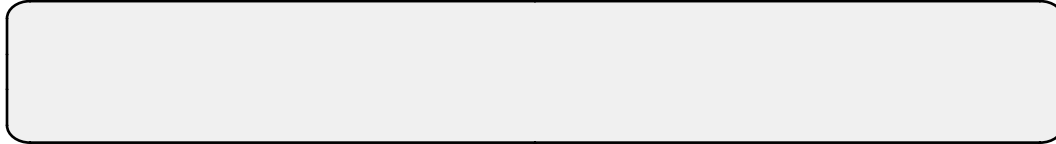

1 x 6 Ipe Decking  
(3/4" x 5 1/2")



5/4 x 6 Ipe Decking  
(1" x 5 1/2")



5/4 x 6 Pre-Grooved Ipe Decking  
(1" x 5 1/2")



Ipe decking







# Tidewater Lumber & Moulding, Inc.

Greenville, South Carolina  
(864) 987-9663 | [tidewaterlumberinc.com](http://tidewaterlumberinc.com)



## TIMBERS

Most of our timbers come rough cut and green. We primarily keep cypress and cedar timbers, both of which are rot resistant, making them ideal for outdoor timber applications. We also carry eastern white pine and oak timbers.

Tidewater has also partnered with Mountain Works Custom Home Design and Toe River Cabins to form Dovetail Cabins, LLC. We provide ready-to-order authentic dovetail framed cypress log cabin kits. For more information, contact Tidewater, or visit: [www.dovetailcabins.com](http://www.dovetailcabins.com)



Hand hewn white pine timbers



**Dovetail Cabins**  
LLC

**AUTHENTIC LOG CABINS**  
GREENVILLE, SC



Pecky cypress on white pine timbers



Loading cypress timbers



Cedar timber posts and braces